

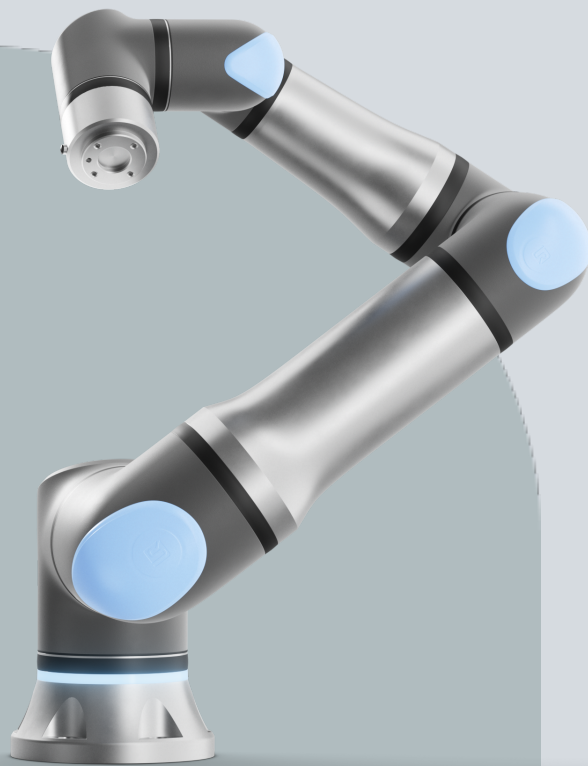

UNIVERSAL ROBOTS

# User Manual

UR18 PolyScope X





The information contained herein is the property of Universal Robots A/S and shall not be reproduced in whole or in part without prior written approval of Universal Robots A/S. The information herein is subject to change without notice and should not be construed as a commitment by Universal Robots A/S. This document is periodically reviewed and revised.

Universal Robots A/S assumes no responsibility for any errors or omissions in this document.

Copyright © 2009-2026 by Universal Robots A/S.

The Universal Robots logo is a registered trademark of Universal Robots A/S.



# 1. Preface

---

## Introduction

Congratulations on the purchase of your new Universal Robots robot, that consists of the robot arm (manipulator), Control Box and the Teach Pendant.

Originally designed to mimic the range of motion of a human arm, the robot arm is composed of aluminium tubes, articulated by six joints, allowing for a high range of flexibility in your automation installation.

The Universal Robots patented programming interface, PolyScope, allows you to create, load and run your automation applications.

---

## About this manual

This manual contains safety information, guidelines for safe use, and instructions to mount the robot arm, Control Box and Teach Pendant. You can also find instructions for how to begin to install and how to start programming the robot.

Read and adhere to the intended uses. Perform a risk assessment. Install and use in accordance with the electrical and mechanical specifications provided in this user manual.

Risk assessment requires an understanding of the hazards, risks and risk reduction measures for the robot application. Robot integration can require a basic level of mechanical and electrical training.

---

## Content disclaimer

Universal Robots A/S continues to improve the reliability and performance of its products, and as such reserves the right to upgrade products, and product documentation, without prior warning. Universal Robots A/S takes every care to ensure the content of the User Manual/s is precise and correct, but takes no responsibility for any errors or missing information.

This manual does not contain warranty information.

---

## Online manuals

Manuals, guides and handbooks can be read online. We have gathered a large number of documents at <https://www.universal-robots.com/manuals>

- PolyScope Software Handbook with descriptions and instructions for the software
  - The Service Handbook with instructions for troubleshooting, maintenance and repair
  - The Script Directory with scripting for in depth programming
-

**UR+** The online showroom UR+[www.universal-robots.com/plus](http://www.universal-robots.com/plus) provides cutting-edge products to customize your UR robot application. You can find everything you need in one place – from tools and accessories to software.

UR+ products connect to and work with UR robots to ensure simple set-up and an overall smooth user experience. All UR+ products are tested by UR.

You can also access the UR+ Partner Program via our software platform [plus.universal-robots.com](http://plus.universal-robots.com) to design more user-friendly products for UR robots.

---

**Academy** The UR Academy site [academy.universal-robots.com](http://academy.universal-robots.com) offers a variety of training opportunities.

---

**myUR** The myUR portal allows you to register all your robots, keep track of service cases and answer general support questions.

Sign into [myur.universal-robots.com](http://myur.universal-robots.com) to access the portal.

In the myUR portal, your cases are handled either by your preferred distributor, or escalated to Universal Robots Customer Service teams.

You can also subscribe to robot monitoring and manage additional user accounts in your company.

---

**Developer suite** The UR Developer Suite [universal-robots.com/products/ur-developer-suite](http://universal-robots.com/products/ur-developer-suite) is a collection of all the tools needed to build an entire solution, including developing URCaps, adapting end-effectors, and integrating hardware.

---

**Support** The support site [www.universal-robots.com/support](http://www.universal-robots.com/support) contains other language versions of this manual

---

**UR forums** The UR Forum [forum.universal-robots.com](http://forum.universal-robots.com) allows robot enthusiasts of all skill levels to connect to UR and each other, to ask questions and to exchange information. While the UR Forum was created by UR+ and our admins are UR employees, the majority of the content is created by you, the UR Forum user.

---

**Data Notice** In compliance with Regulation (EU) 2854/2023 (“Data Act”), a Data Notice for this product along with instructional information on how to obtain Readily Available data can be found at the following location: <https://www.universal-robots.com/legal/data-notice/>

---



**Address**

Universal Robots A/S  
Energivej 51  
DK-5260 Odense Denmark  
Tel.: +45 89 93 89 89  
Please see the official Universal Robots website for regional offices.

---

# Contents

<b>1. Preface</b>	<b>6</b>
<b>2. Liability and Intended Use</b>	<b>15</b>
2.1. Limitation of Liability	15
2.2. Intended Use	15
<b>3. Your Robot</b>	<b>17</b>
3.1. Technical Specifications UR18	17
3.2. What Is In The Box	18
3.2.1. Robot Arm	19
3.2.2. Control Box	20
3.2.3. Teach Pendant with 3-Position Enabling Device	21
3.2.4. Robot Cables	26
3.2.5. PolyScope X Overview	27
<b>4. Safety</b>	<b>32</b>
4.1. General	32
4.2. Safety Message Types	33
4.3. General Warnings and Cautions	34
4.4. Integration and Responsibility	36
<b>5. Lifting and Handling</b>	<b>37</b>
5.1. Robot Arm	41
5.1.1. Round Sling Use	42
5.2. Control Box and Teach Pendant	43
<b>6. Assembly and Mounting</b>	<b>45</b>
6.1. Securing the Robot Arm	46
6.2. Dimensioning the Stand	47
6.3. Mounting Description	50
6.3.1. Control Box Mounting	51
6.3.2. Control Box Clearance	52
6.4. Workspace and Operating Space	52
6.4.1. Singularity	53
6.4.2. Fixed and Movable Installation	55
6.5. Robot Connections: Base Flange Cable	56
6.6. Robot Connections: Robot Cable	57
6.7. Mains Connections	58
<b>7. First Boot</b>	<b>60</b>
7.1. Powering On the Robot	61
7.2. Inserting the Serial Number	61



- 7.3. Starting the Robot Arm ..... 62
- 7.4. Powering Down the Robot ..... 63
- 7.5. Application Tab ..... 64
- 7.6. Move the Robot with 3PE Teach Pendant ..... 64
- 8. Installation ..... 67**
  - 8.1. Electrical Warnings and Cautions ..... 67
  - 8.2. Control Box Connection Ports ..... 69
  - 8.3. Ethernet ..... 70
  - 8.4. 3PE Teach Pendant Installation ..... 71
    - 8.4.1. Hardware Installation ..... 71
    - 8.4.2. Software Installation ..... 72
  - 8.5. Controller I/O ..... 74
    - 8.5.1. Digital Input and Output ..... 76
    - 8.5.2. Using the Wired I/O Tab ..... 78
    - 8.5.3. Drive Power Indicator ..... 79
  - 8.6. Safety I/O ..... 81
    - 8.6.1. Safety I/O Signals ..... 84
    - 8.6.2. I/O Setup ..... 89
    - 8.6.3. Using I/O for Mode Selection ..... 92
    - 8.6.4. Three Position Enabling Device ..... 94
  - 8.7. General Purpose Digital I/O ..... 95
    - 8.7.1. Remote ON/OFF control ..... 96
  - 8.8. General Purpose Analog I/O ..... 97
  - 8.9. Remote Mode in Safety Overview ..... 98
- 9. End Effector Integration ..... 101**
  - 9.1. Maximum Payload ..... 101
  - 9.2. Securing Tool ..... 102
  - 9.3. Tool I/O ..... 105
    - 9.3.1. Tool I/O Installation Specifications ..... 107
    - 9.3.2. Tool Power Supply ..... 108
    - 9.3.3. Tool Digital Inputs ..... 108
    - 9.3.4. Tool Digital Outputs ..... 110
    - 9.3.5. Tool Analogue Inputs ..... 111
  - 9.4. Set Payload ..... 112
    - 9.4.1. Safely Setting the Active Payload ..... 112
- 10. Safety Configuration ..... 113**
  - 10.1. Safety Related Functions and Interfaces ..... 113
    - 10.1.1. Configurable Safety Functions ..... 114
  - 10.2. Settings ..... 115

10.2.1. Password .....	115
10.2.2. Secure Shell (SSH) Access .....	118
10.2.3. Permissions .....	119
10.2.4. Services .....	120
10.3. Unlock Safety Settings .....	120
10.4. Safety Menu Settings .....	120
10.4.1. Robot Limits .....	121
10.4.2. Joint Limits .....	125
10.4.3. Tool Position Restriction .....	125
10.4.4. Safety Planes .....	127
10.4.5. I/O Planes .....	131
10.4.6. Hardware .....	134
10.4.7. Three Position .....	136
10.4.8. PROFIsafe .....	136
10.4.9. Safe Home .....	142
10.4.10. Tool Direction .....	148
<b>11. Cybersecurity Threat Assessment .....</b>	<b>153</b>
11.1. General Cybersecurity .....	153
11.2. Cybersecurity Requirements .....	153
11.3. Cybersecurity Hardening Guidelines .....	155
<b>12. Communication Networks .....</b>	<b>156</b>
12.1. MODBUS .....	157
12.2. Profinet .....	159
12.3. Ethernet/IP .....	163
12.4. UR Connect .....	165
<b>13. Risk Assessment .....</b>	<b>169</b>
13.1. Pinch Hazard .....	172
13.2. Stopping Time and Stopping Distance .....	172
13.3. Stop Categories .....	182
<b>14. Emergency Events .....</b>	<b>183</b>
14.1. Emergency Stop .....	183
14.2. Movement Without Drive Power .....	184
14.3. Clamp Connection: Disassembly .....	185
14.4. Operational Mode .....	187
<b>15. Transportation .....</b>	<b>191</b>
15.1. Transportation Without Packaging .....	192
15.2. Teach Pendant Storage .....	192
15.3. Long Term Storage .....	193
<b>16. Maintenance and Repair .....</b>	<b>194</b>



16.1. Testing Stopping Performance .....	195
16.2. Robot Arm Cleaning and Inspection .....	196
16.3. Cleaning TP and CB .....	199
16.4. Software Installation .....	200
<b>17. Disposal and Environment .....</b>	<b>202</b>
<b>18. Declarations and Certifications .....</b>	<b>204</b>
18.1. Declaration of Incorporation (original) .....	205
18.2. Certifications UR18 .....	207
18.3. Certificates UR18 .....	208
<b>19. Safety Functions Table .....</b>	<b>213</b>



## 2. Liability and Intended Use

### 2.1. Limitation of Liability

**Description** Any information provided in this manual must not be construed as a warranty, by UR, that the industrial robot will not cause injury or damage, even if the industrial robot complies with all safety instructions and information for use.

### 2.2. Intended Use

**Description**



**NOTICE**

Universal Robots takes no responsibility and assumes no liability for unapproved uses of its robots or uses for which its robots are not intended and Universal Robots will provide no support for unintended uses.



**READ MANUAL**

Failure to use the robot in accordance with the intended use can result in hazardous situations.

- Read and follow the recommendations for intended use and the specifications provided in the User Manual.

Universal Robots robots are intended for industrial use, to handle tools/end effectors and fixtures, or to process or transfer components or products.

All UR robots are equipped with safety functions, which are purposely designed to enable collaborative applications, where the robot application operates together with a human. The safety function settings must be set to the appropriate values as determined by the robot application risk assessment.

The robot and Control Box are intended for inside use where, normally, only non-conductive pollution occurs i.e. Pollution degree 2 environments.

Collaborative applications are only intended for non-hazardous applications, where the complete application, including tool/end effector, work piece, obstacles and other machines, is low risk according to the risk assessment of the specific application.

**WARNING**

Using UR robots or UR products outside of the intended uses can result in injuries, death and/or property damage. Do not use the UR robot or products for any of the below unintended uses and applications:

- Medical use, i.e. uses relating to disease, injury or disability in humans including the following purposes:
    - Rehabilitation
    - Assessment
    - Compensation or alleviation
    - Diagnostic
    - Treatment
    - Surgical
    - Healthcare
    - Prosthetics and other aids for the physically impaired
    - Any use in proximity to patient/s
  - Handling, lifting, or transporting people
  - Any application requiring compliance with specific hygienic and/or sanitation standards, such as proximity or direct contact with food, beverage, pharmaceutical, and /or cosmetic products.
    - UR joint grease leaks, and can also be released as vapor into the air.
    - UR joint grease is not “food grade”.
    - UR robots do not meet any food, National Sanitization Foundation (NSF), Food and Drug Administration (FDA), or hygienic design standards.
- Hygienic standards, for example ISO 14159 and EN 1672-2, require a hygiene risk assessment be conducted.
- Any use, or any application, deviating from the intended use, specifications, and certifications of UR robots or UR products.
  - Misuse is prohibited as the result could be death, personal injury, and /or property damage

UNIVERSAL ROBOTS EXPRESSLY DISCLAIMS ANY EXPRESS OR IMPLIED WARRANTY OF FITNESS FOR ANY PARTICULAR USE.

**WARNING**

Failure to consider the added risks due to the reach, payloads, operating torques and speeds associated with robot application, can result in injury or death.

- Your application risk assessment shall include the risks associated with the application's reach, motion, payload and speed of the robot, end effector and workpiece.

# 3. Your Robot

**Description** This section provides an overview of the robot system components, including hardware, connection accessories, and interfaces required for installation, operation, and user interaction.

## 3.1. Technical Specifications UR18

<b>General specification</b>	Maximum payload	18 kg (39.7lbs)
	Reach	950 mm / 37.4 in
	Degrees of freedom	6 rotating joints
	Programming	PolyScope 5 GUI on 12" touchscreen or PolyScope X GUI on 12" touchscreen
	Power consumption (average)	550W Approx. 350W using a typical program
	Ambient temperature range	0-50 °C with reduced performance from 35 °C and up.
	Safety functions	21 configurable safety functions. PLd Category 3 in accordance with: EN ISO 13849-1.

<b>Performance</b>	Force Torque sensor accuracy	10 N
--------------------	------------------------------	------

<b>Movement</b>	Speed	All wrist joints: Max 300 °/s Elbow joint: Max 240 °/s Base and Shoulder joints: Max 180 °/s Maximum TCP speed: Approx. 4 m/s / Approx. 157.5 in/s.
	Pose repeatability	± 0.05 mm / ± 0.0019 in per ISO 9283
	Joint ranges	± 360 ° for all joints

<b>Features</b>	IP classification	Robot Arm: IP65, Control Box: IP44, Teach Pendant: IP54
	Pollution degree	2
	Humidity	90% non-condensing
	Noise	Robot Arm: less than 65 dB(A), Control Box: less than 50 dB(A)
	Tool I/O ports	2 digital in, 2 digital out, 2 analog in
	Tool I/O power supply & voltage	2 A (Dual pin) 1 A (Single pin) & 12 V/24 V

<b>Physical</b>	Footprint	Ø204 mm / 8,03 in
	Materials	Aluminium, PC/ASA plastic, steel
	Robot arm weight	39,2 kg (86.42 lbs)

<b>Control Box</b>	Control Box power source	100-240 VAC, 47-440 Hz
	Control Box size (W × H × D)	460 mm x 449 mm x 254mm / 18.2 in x 17.6 in x 10 in
	Control Box weight	12 kg / 26.5 lb
	Control Box I/O ports	16 digital in, 16 digital out, 2 analog in, 2 analog out
	Control Box I/O power supply	24 V/2 A
	System update frequency	500 Hz
	Communication	MODBUS TCP & EthernetNet/IP adapter, PROFINET, USB 2.0, USB 3.0
	Short-Circuit Current Rating (SCCR)	200A

<b>Teach pendant</b>	TP size (W × H × D)	300 mm x 231 mm x 50 mm
	TP weight	1.8 kg / 3.961 lb
	TP cable: Teach Pendant to Control Box	4.5 m / 177 in

<b>Robot Cable</b>	Robot Cable: robot arm to Control Box	High flex (PUR) 3 m/118 in x 12.1 mm
		High flex (PUR) 6 m/236 in x 12.1 mm
		High flex (PUR) 12 m/472.4 in x 12.1 mm

## 3.2. What Is In The Box

<b>Description</b>	This section identifies the contents of the product package.
--------------------	--

**In the boxes**

- Robot arm
  - Control Box
  - 3PE Teach Pendant
  - Mounting bracket for the Control Box
  - Mounting bracket for the 3PE Teach Pendant
  - Key for opening the Control Box
  - Cable for connecting the robot arm and the Control Box (multiple options available depending on robot size)
  - Mains cable or power cable compatible with your region
  - Round sling or lifting sling (depending on robot size)
  - Tool cable adapter (depending on robot version)
  - This manual
- 

### 3.2.1. Robot Arm

---

**About the robot arm**

The Joints, Base and Tool Flange are the main components of the robot arm. The controller coordinates joint motion to move the robot arm.

Attaching an end effector (tool) to the Tool Flange at the end of the robot arm, allows the robot to manipulate a workpiece. Some tools have a specific purpose beyond manipulating a part, for example, QC inspection, applying adhesives and welding.

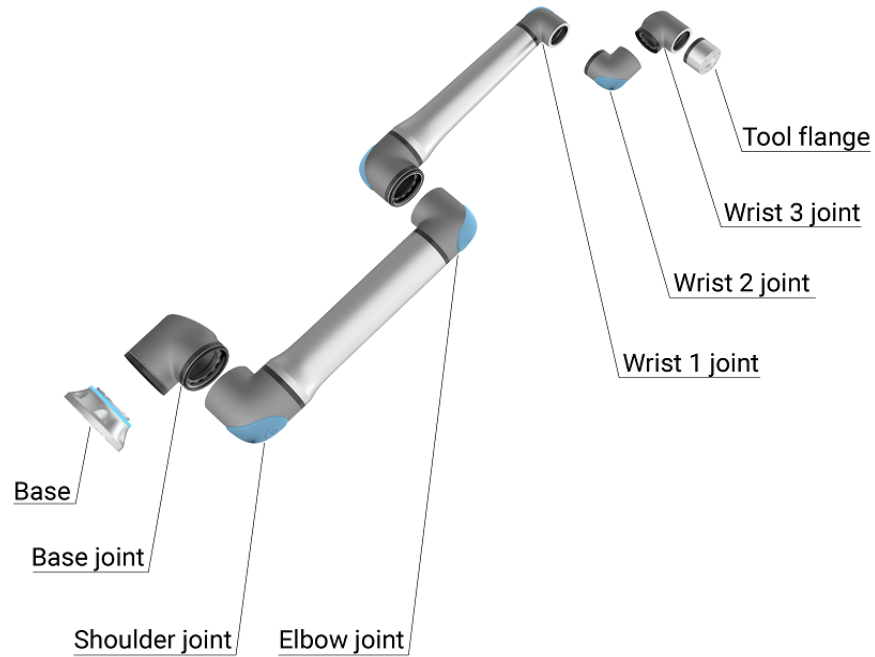

*The main components of the robot arm.*

- **Base:** where the robot arm is mounted.
- **Shoulder** and **Elbow:** make larger movements.
- **Wrist 1** and **Wrist 2:** make finer movements.
- **Wrist 3:** where the tool is attached to the Tool Flange.

The robot is partly completed machinery, as such a Declaration of Incorporation is provided. A risk assessment is required for each robot application.

### 3.2.2. Control Box

#### **About the Control Box**

The Control Box houses the connection ports and Controller Inputs and Outputs (I/O) used in robot arm programs and installations. The connection ports are used for external connections. The I/O are groups of electrical interfaces used for communication and configuration.



External connections ports.

Safety		Remote		Power		Configurable Inputs		Configurable Outputs		Digital Inputs		Digital Outputs		Analog	
Emergency Stop	24V	12V		PWR	24V	24V	0V	0V	24V	24V	0V	0V	Analog Inputs	AG	
	EI0	GND		GND	24V	24V	0V	0V	D10	D14	DO0	DO4		A10	
	EI1	ON		24V	24V	24V	0V	0V	24V	24V	0V	0V		AG	
	EI1	OFF		0V	24V	24V	0V	0V	D11	D15	DO1	DO5		AG	
Safeguard Stop	24V				24V	24V	0V	0V	24V	24V	0V	0V		AG	
	SI0	DI11	DI10	DI9	DI8	24V	0V	0V	D12	D16	DO2	DO6		AG	
	SI1				0V	24V	0V	0V	24V	24V	0V	0V		AG	
						24V	0V	0V	DI3	DI7	DO3	DO7		AG	
						CI3	CI7	CO3						AO1	

Input and Output (I/O) groups.

For detailed descriptions of the Control Box connection ports and the Controller I/O, see the Installation.

### 3.2.3. Teach Pendant with 3-Position Enabling Device

**Description**

Depending on the robot generation, your Teach Pendant can include a built-in 3PE device. This is called a 3-Position Enabling Teach Pendant (3PE TP). Higher payload robots can only use the 3PE TP.

If you are using a 3PE TP, the buttons are located on the underside of the Teach Pendant, as illustrated below. You can use either button, according to your preference.

If the Teach Pendant is disconnected, you are required to connect and configure an external 3PE device. The 3PE TP functionality extends to the PolyScope interface, where there are additional functions in the Header.

**NOTICE**

- If you have bought a UR15, UR20, UR30, UR8 Long, or UR18 robot, a Teach Pendant without the 3PE device will not work. See the **Robot and 3PE TP compatibility table** below.
- Using a UR15, UR20, UR30, UR8 Long, or UR18 robot requires an external enabling device or a 3PE Teach Pendant when programming, or teaching, within the reach of the robot application. See ISO 10218-2.
- The 3PE Teach Pendant is not included with the purchase of the OEM Control Box, so enabling device functionality is not provided.

**Robot and 3PE TP Compatibility Table**

Compatibility Table per UR Robot Generations		
Robot Generation	Standard Teach Pendant	3PE Teach Pendant
e-Series	√	√
UR Series		√
<i>Please note that UR Series robots are not compatible with the Standard Teach Pendant.</i>		

Compatibility Table per Individual UR Robots			
Robot Model*	Standard Teach Pendant	3PE Teach Pendant	No Teach Pendant
UR3e	√	√	√
UR5e	√	√	√
UR7e	√	√	√
UR10e	√	√	√
UR12e	√	√	√
UR16e	√	√	√
UR8 Long		√	√
UR15		√	√
UR18		√	√
UR20		√	√
UR30		√	√
<i>*This includes both Standard and OEM Control Box.</i>			

**Overview of TP**

1. Power button
2. Emergency Stop button
3. USB port (comes with a dust cover)
4. 3PE buttons



**Freedrive**

A Freedrive robot symbol is located under each 3PE button, as illustrated below.



### 3PE Teach Pendant Button Functions

Description



**NOTICE**

The 3PE buttons are only active in Manual mode. In Automatic mode, robot movement does not require 3PE button action.

The table below describes the functions of the 3PE buttons.

Position		Description	Action
1	Release	There is no pressure on the 3PE button. It is not pressed.	Robot movement is stopped in Manual mode. Power is not removed from the robot arm and the brakes remain released.
2	Light-press (Grip lightly)	There is some pressure on the 3PE button. It is pressed to a middle point.	Allows your program to play when the robot is in Manual mode.
3	Tight-press (Grip tightly)	There is full pressure on the 3PE button. It is pressed all the way down.	Robot movement is stopped in Manual mode. Robot is in 3PE Stop.

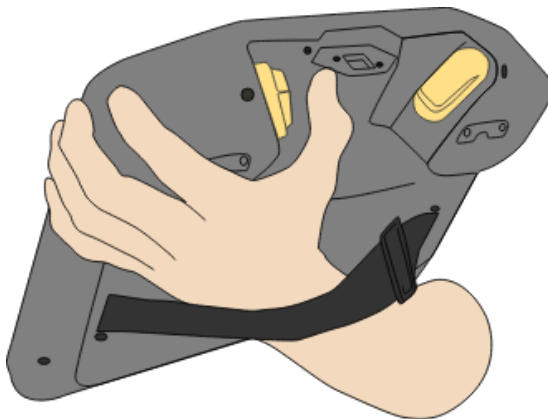

Button release

Button press

## 3.2.4. Robot Cables

### Description

This section lists the UR Series robot cables and warns against improper cable selection and the use of incompatible cables.



#### WARNING

The "Standard (black)" and "High flex e-Series (blue)" cables are not compatible with UR20 and UR30 robots.

- Do not use an e-Series cable to connect a UR20 or a UR30 robot arm.
- Always use the High flex cable that is compatible with UR20 and UR30 robot arms.



#### WARNING: ELECTRICITY

Conducting installation and/or maintenance of equipment connected to a power source can result in injury or death due to electric shock.

- Disconnect equipment from the power source before conducting installation or maintenance tasks.



#### NOTICE

Improper cable selection, usage, or connections can result in loss of power to the robot arm.

- The maximum robot cable connection from the robot arm to the Control Box is 12 meter.
- Is possible to extend a 6 meter High flex cable with a single 3 meter High flex cable .
- Do not extend any other cable combination other than the one above.



#### NOTICE

Connecting the Base Flange cable directly to any Control Box can result in damage to equipment and property.

- Do not connect the Base Flange cable to your Control Box.
- Always use a UR robot cable to connect the Base Flange to your Control Box.



#### READ MANUAL

Failure to use the robot in accordance with the intended use can result in hazardous situations.

- Read and follow the recommendations for intended use and the specifications provided in the User Manual.

Cable type	Item	Length	Mat.	Dia.	Torsion	Max speed	Max acceleration	Max tensile strain		Bend		Mating cycles
								static	dynamic	radius	cycles	
High flex (blue)	201235	3m	PUR	14.6mm	±30°/m	120 m/min	10 m/s <sup>2</sup>	50N/mm <sup>2</sup>	20N/mm <sup>2</sup>	4 x d (static install) 8 x d (dynamic install)	5Mil at 8 x d	500
	200113	6m										
	200114	12m										

### 3.2.5. PolyScope X Overview

#### Overview

PolyScope X is the graphical user interface (GUI) installed on the teach pendant that operates the robot arm via touch screen. The PolyScope X interface allows you to create, load, and execute programs.





**NOTICE**

Always update your software to latest version.

**To view  
Main  
Screen**

1. Tap the 3D Viewer icon  on the main navigation. This gives you a three-dimensional view of the robot arm in X-Y-Z coordinates.
2. To maximize the 3D viewing area, collapse the right drawer using the sidebar:

- Tap once the Move icon 
- Tap twice the Program structure icon 
- Tap twice the Global Variables icon 

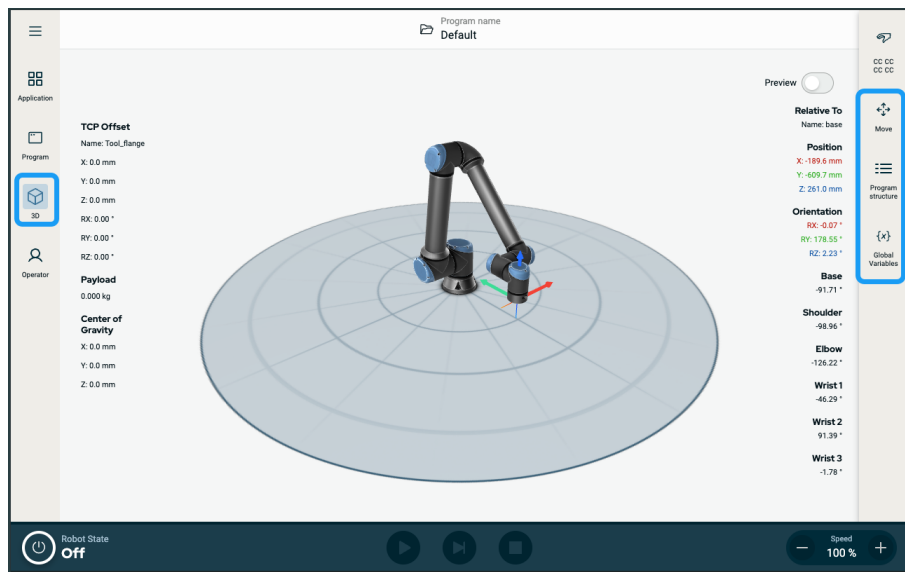

Copyright © 2009-2026 by Universal Robots A/S. All rights reserved.

Screen Layout

The PolyScope X GUI is divided as shown in the following illustration:

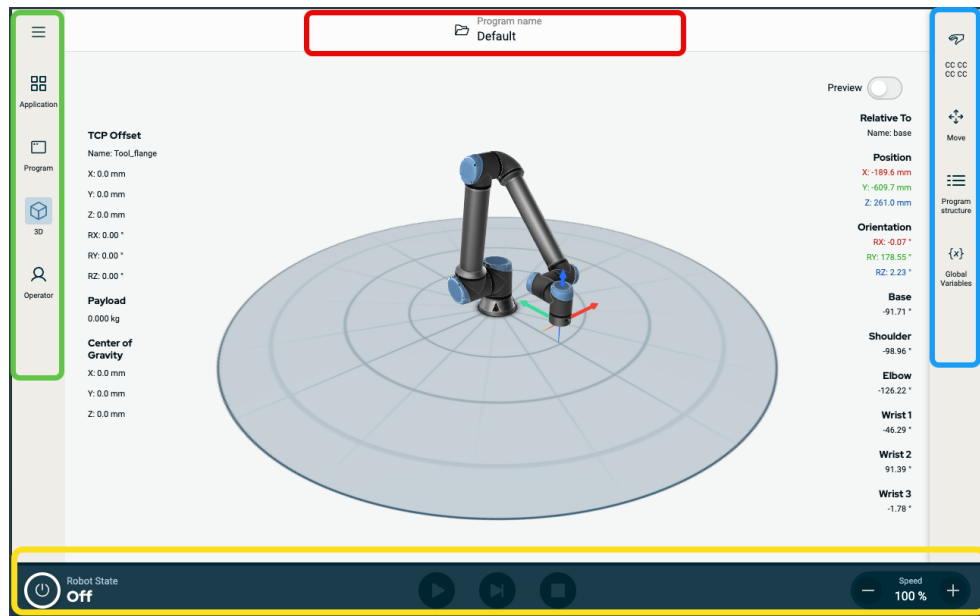

- **Header** - in red-border box. Also called **system manager**.  
Contains a folder to load, create, and edit programs and access URCaps.
- **Main Navigation** - in green-border box. Also called **navigation hub**.  
Contains icon/fields to select a main screen:
  - Hamburger icon
  - Application
  - Program
  - 3D Viewer
  - Operator Screen
- **Sidebar** - in blue-border box. Also called **multitasking panel**.  
Contains icon/fields to select a multitask screen:
  - Safety checksum icon
  - Move
  - Program structure
  - Global Variables
- **Footer** - in yellow-border box. Also called **robot control bar**.  
Contains buttons to control robot state, speed, and program run/play.

Copyright © 2009-2026 by Universal Robots A/S. All rights reserved.

## Screen Combinations

The main screen and the multitask screen make up the operating screen combination for the robot.

The multitask screen is independent of the main screen so you can do separate tasks. For example, you can configure a program in the main screen while moving the robot arm in the multitask screen. You also can hide the multitask screen if it is not needed.

- **Main screen**  
Contains fields and options to manage and monitor robot actions.
- **Multitask screen**  
Contains fields and options often relating to the main screen.

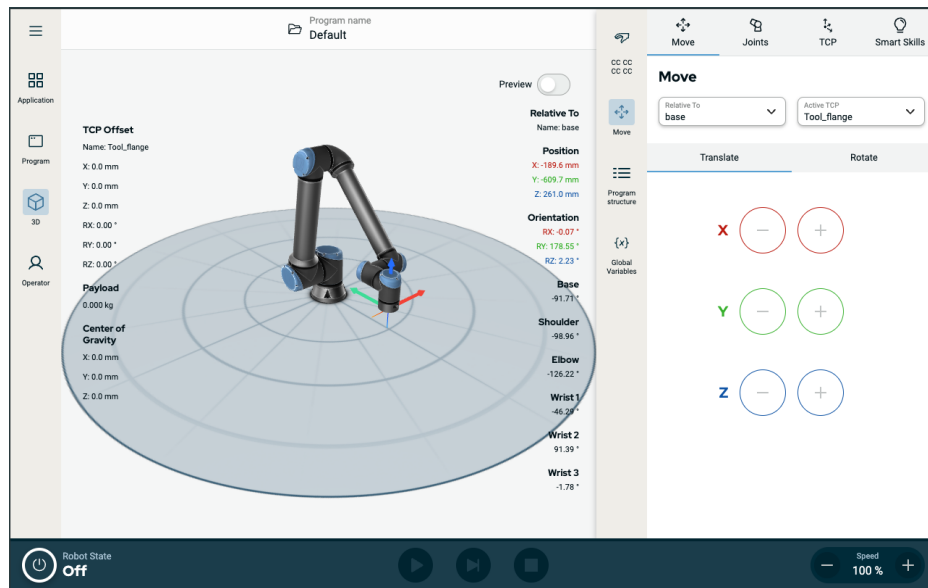

Figure 1.1: Main screen and multitask screen

## To show/hide the Multitask Screen

1. In the sidebar, tap any field to show the multitask screen.  
The sidebar expands to the middle of the screen so the multitask screen becomes visible.
2. Tap the currently selected field in the sidebar to hide the multitask screen.

## Touch Screen

### Description

The **Teach Pendant touch screen** is optimized for use in industrial environments. Unlike consumer electronics, teach pendant touch screen sensitivity is, by design, more resistant to environmental factors such as:

- Water droplets and/or machine coolant droplets
- Radio wave emissions
- Other conducted noise from the operating environment



**Using the Touch Screen**

The touch sensitivity is designed to avoid false selections on PolyScope X and to prevent unexpected motion of the robot.

For best results, use the tip of your finger to make a selection on the screen. In this manual/handbook, this is referred to as a **tap**.

A commercially available stylus may be used to make selections on the screen, if desired.

The preceding section lists and defines the icons/tabs and buttons in the PolyScope X interface.

---

## 4. Safety

---

**Description** Read the safety information here to understand key safety guidelines, important safety messages and your responsibilities when working with the robot. System design and installation are not covered here.

---

### 4.1. General

---

**Description** Read the general safety information and the instructions and guidance pertaining to risk assessment and the intended use. Subsequent sections describe and define safety-related functions particularly relevant for collaborative applications.



#### WARNING

An application risk assessment must be performed for the safety of personnel and equipment.

Read and understand the specific engineering data relevant to mounting and installation, in order to understand the integration of UR robots before the robot is powered on for the first time.

It is essential to observe and follow all assembly instructions in the following sections of this manual.



#### NOTICE

Universal Robots disclaims any and all liability if the robot (arm Control Box with or without Teach Pendant) is damaged, changed or modified in any way. Universal Robots cannot be held responsible for any damages caused to the robot or any other equipment due to programming errors, unauthorized access to the UR robot and its contents, or malfunctioning of the robot.

---

## 4.2. Safety Message Types

### Description

Safety messages are used to emphasize important information. Read all the messages to help ensure safety and to prevent injury to personnel and product damage.



#### WARNING

Indicates a hazardous situation that, if not avoided, can result in death or serious injury.



#### WARNING: ELECTRICITY

Indicates a hazardous electrical situation that, if not avoided, can result in death or serious injury.



#### WARNING: HOT SURFACE

Indicates a hazardous hot surface where injury can result from contact and non-contact proximity.



#### CAUTION

Indicates a hazardous situation that, if not avoided, can result in injury.



#### GROUND

Indicates grounding.



#### PROTECTIVE GROUND

Indicates protective grounding.



#### NOTICE

Indicates the risk of damage to equipment and/or information to be noted.



#### READ MANUAL

Indicates more detailed information that should be consulted in the manual.

## 4.3. General Warnings and Cautions

**Description** The following warnings messages can be repeated, explained or detailed in subsequent sections.



### WARNING

Failure to adhere to the general safety practices, listed below, can result in injury or death.

- Verify the robot arm and tool/end effector are properly and securely bolted in place.
- Verify the robot application has ample space to operate freely.
- Verify the personnel are protected during the lifetime of the robot application including transport, installation, commissioning, programming/ teaching, operation and use, dismantling and disposing.
- Verify robot safety configuration parameters are set to protect personnel, including those who can be within reach of the robot application.
- Avoid using the robot if it is damaged.
- Avoid wearing loose clothing or jewelry when working with the robot. Tie back long hair.
- Avoid placing any fingers behind the internal cover of the Control Box.
- Inform users of any hazardous situations and the protection that is provided, explain any limitations of the protection and the residual risks.
- Inform users of the location of the emergency stop button(s) and how to activate the emergency stop in case of an emergency or an abnormal situation.
- Warn people to keep outside the reach of the robot, including when the robot application is about to start-up.
- Be aware of robot orientation to understand the direction of movement when using the Teach Pendant.
- Adhere to the requirements in ISO 10218-2.



### WARNING

Handling tools/end effectors with sharp edges and/or pinch points can result in injury.

- Make sure tools/end effectors have no sharp edges or pinch points.
- Protective gloves and/or protective eyeglasses could be required.



**WARNING: HOT SURFACE**

Prolonged contact with the heat generated by the robot arm and the Control Box, during operation, can lead to discomfort resulting in injury.

- Do not handle or touch the robot while in operation or immediately after operation.
- Check the temperature on the log screen before handling or touching the robot.
- Allow the robot to cool down by powering it off and waiting one hour.



**CAUTION**

Failure to perform a risk assessment prior to integration and operation can increase risk of injury.

- Perform a risk assessment and reduce risks prior to operation.
- If determined by the risk assessment, do not enter the range of the robot movement or touch the robot application during operation. Install safeguarding.
- Read the risk assessment information.



**CAUTION**

Using the robot with untested external machinery, or in an untested application, can increase the risk of injury to personnel.

- Test all functions and the robot program separately.
- Read the commissioning information.



**NOTICE**

Very strong magnetic fields can damage the robot.

- Do not expose the robot to permanent magnetic fields.



**READ MANUAL**

Verify all mechanical and electrical equipment is installed according to relevant specifications and warnings.

## 4.4. Integration and Responsibility

---

### Description

The information in this manual does not cover designing, installing, integrating and operating a robot application, nor does it cover all peripheral equipment that can influence the safety of the robot application. The robot application must be designed and installed in accordance with the safety requirements set forth in the relevant standards and regulations of the country where the robot is installed.

The person/s integrating the UR robot are responsible for ensuring that the applicable regulations in the country concerned are observed and that any risks in the robot application are adequately reduced. This includes, but is not limited to:

- Performing a risk assessment for the complete robot system
  - Interfacing other machines and additional safeguarding if required by the risk assessment
  - Setting the correct safety settings in the software
  - Ensuring safety measures are not modified
  - Validating the robot application is designed, and installed and integrated
  - Specifying instructions for use
  - Marking the robot installation with relevant signs and contact information of the integrator
  - Retaining all documentation; including the application risk assessment, this manual and additional relevant documentation.
-

# 5. Lifting and Handling

**Description**

The robot arms come in different sizes and weights, so it is important to use the appropriate lifting and handling techniques for each model. Here you can find information on how to safely lift and handle the robot.

**Proper lifting and handling**

1. Transport the robot to the site using a forklift.
2. Open the box as illustrated.

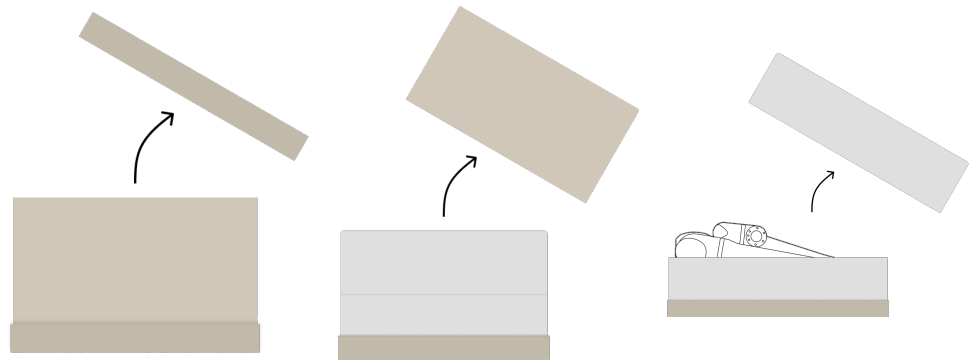

3. Securely strap the robot arm with the lifting sling.

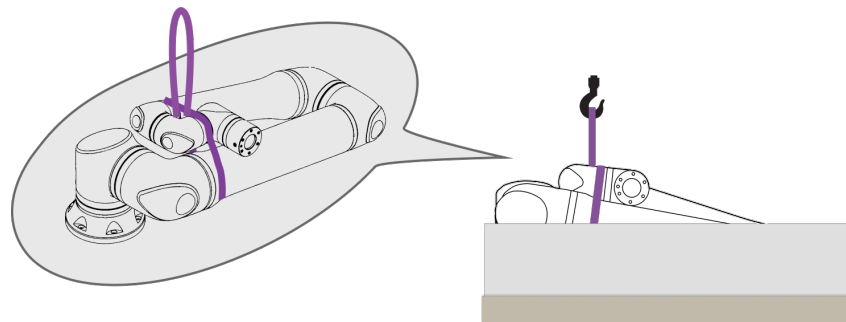

4. Lift the robot arm out of the box using the strap and hook.

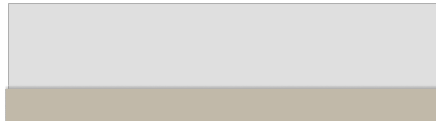
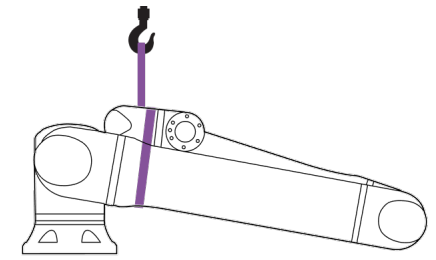

**CAUTION**

Use a lifting equipment when lifting heavier robot arm.

5. While the robot is lifted, support it to rotate and hang as illustrated.

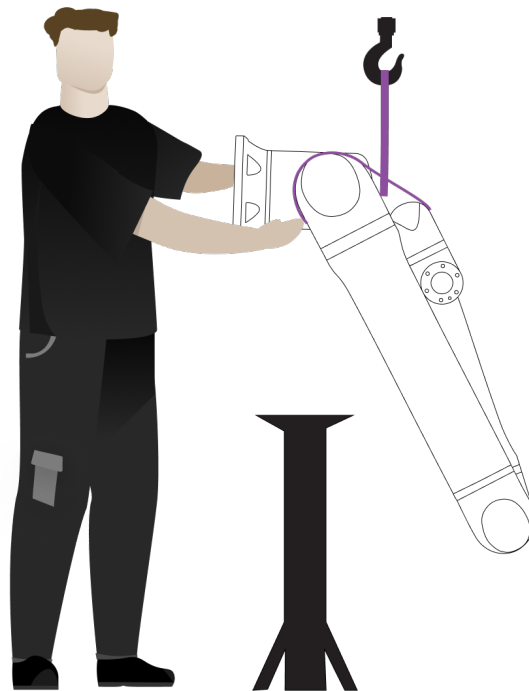

**Mounting  
the Robot  
Arm**

The robot arm can be mounted sideways, upside-down or in an angle ( $\pm 45^\circ$ ).

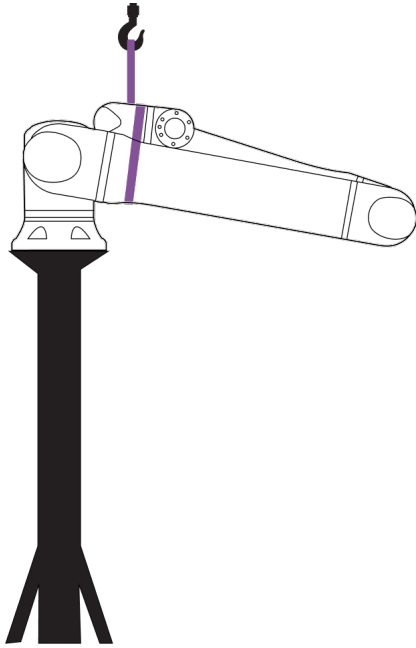

Sideways mounting

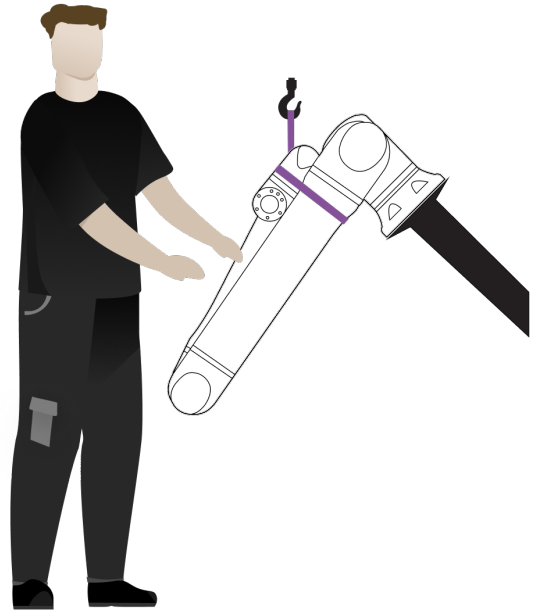

Angular mounting ( $\pm 45^\circ$ )

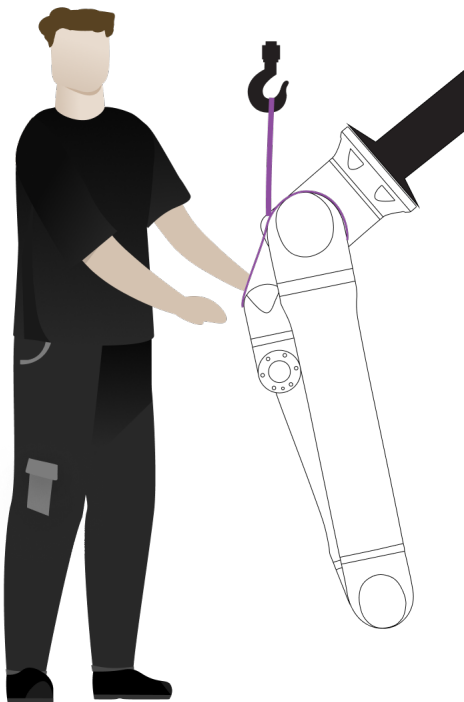

Upside-down mounting

1. Mount the robot arm. Tighten the screws and apply torque as specified in the relevant user manual.

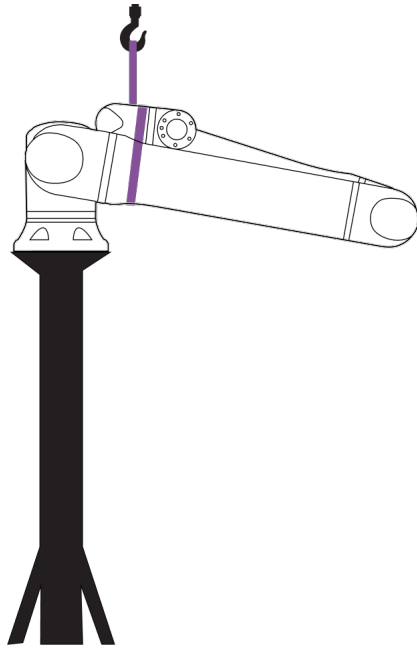

2. Remove the strap.
3. Power on the robot and reposition shoulder joint as intended.

**NOTICE**

For sideways mounting, no need to power on the robot.

4. Re-place the strap.

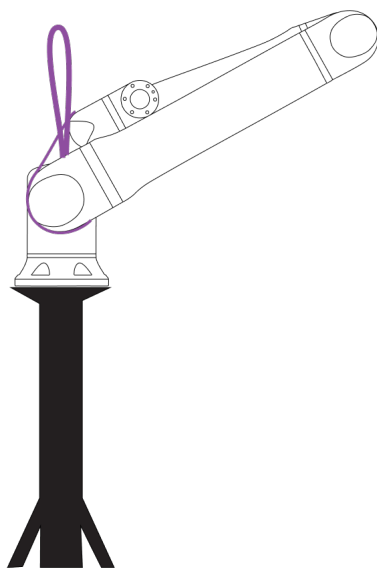



**WARNING**

Lifting or movement of heavy parts can cause injury.

- Lifting apparatus/aid to lift can be required.
- Unpack the robot arm in the desired workspace to minimize lifting and movement of heavy parts.



**WARNING**

Incorrect assembly of components and/or wiring can lead to injury.

- Personal protective gear (footwear, eyewear, gloves) can be required.



**CAUTION**

Failure to use an appropriate lifting device for the weight of the robot can lead to injury and property damage.

For UR30:

- The lifting device shall be capable of lifting 63.5 kg - robot only.

For UR20:

- The lifting device shall be capable of lifting 64 kg - robot only.

For UR15:

- The lifting device shall be capable of lifting 41 kg - robot only.

For UR8 Long:

- The lifting device shall be capable of lifting 44.7 kg - robot only.

For UR18:

- The lifting device shall be capable of lifting 39.2 kg - robot only.



**NOTICE**

There may be specific regulations for assembly lifting in your region.

- Follow the local regulations and guidelines for lifting.

For detailed mounting descriptions, see Assembly section.

## 5.1. Robot Arm

**Description**

The robot arm, depending upon weight, can be carried by one or two people unless the sling is provided. If the sling is provided, equipment for lifting and transport is required.

## 5.1.1. Round Sling Use

### Description

The round sling is provided by UR with UR Series robots.

According to the manufacturer, the round sling conforms to the following standards:

- EN 1492-1 :2000+A1 :2008 Textile slings - Safety - Flat woven webbing slings, made of man-made fibers, for general purpose use.
- EN 1492-2 :2000+A1 :2008 Textile slings - Safety - Round slings, made of man-made fibers, for general purpose use.



#### WARNING

Using the round sling without an inspection can lead to injury.

- Inspect the sling before and after each use.
- Inspect the sling during use if possible.



#### WARNING

Using a damaged round sling can result in injury.

- Carefully examine the sling visually before each use.
- Do not use the sling if it is cracked, ripped, or the stitching is loose.
- Do not use the sling if there are signs of heat damage.



#### CAUTION

Incorrect storage and/or handling can cause damage to the round sling.

- Keep the sling away from acids and bases.
- Protect the sling against sharp edges and friction.
- Do not tie a knot in the sling.





#### NOTICE

There may be specific regulations for inspecting lifting equipment in your region.

- Observe local regulations regarding inspection of lifting equipment.
- Observe local regulations regarding inspection frequency of lifting equipment.

**Table**

Round Sling Description			
Item	Round sling 1T x 1M/2M		
Color	Violet (according to EN 1492-2)		
Material	Polyester		
WLL Factor	1.0 (1000 KG)	Straight Lift	
	0.8 (800 KG)	Choke Hitch	

## 5.2. Control Box and Teach Pendant

**Description**

The Control Box and the Teach Pendant can each be carried by one person. While in use, all cables are to be coiled and held to prevent tripping hazards.



# 6. Assembly and Mounting

**Description** Install and power on the robot arm and Control Box to start using PolyScope.

**Assemble the robot** You have to assemble the robot arm, Control Box and Teach Pendant to be able to continue.

1. Unpack the robot arm and the Control Box.
2. Mount the robot arm on a sturdy, vibration-free surface.
3. Place the Control Box on its Foot.
4. Connect the robot cable to the robot arm and the Control Box.
5. Insert the SD-card into the Control Box.
6. Plug in the mains, or main power cable, of the Control Box.



**WARNING**

Failure to secure the robot arm to a sturdy surface can lead to injury caused by the robot falling.

- Ensure the robot arm is secured to a sturdy surface.

**Insert SD-card**

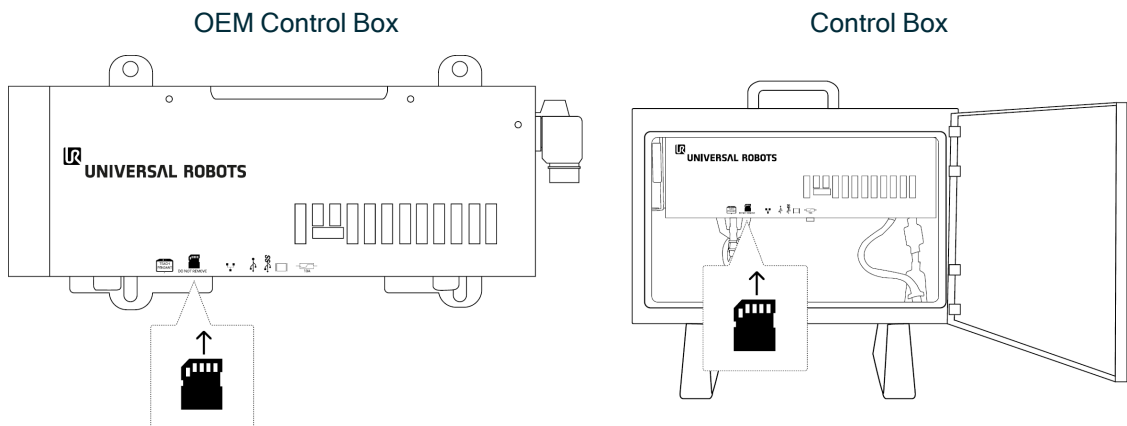

## 6.1. Securing the Robot Arm

Dimensions and hole pattern for mounting the robot.

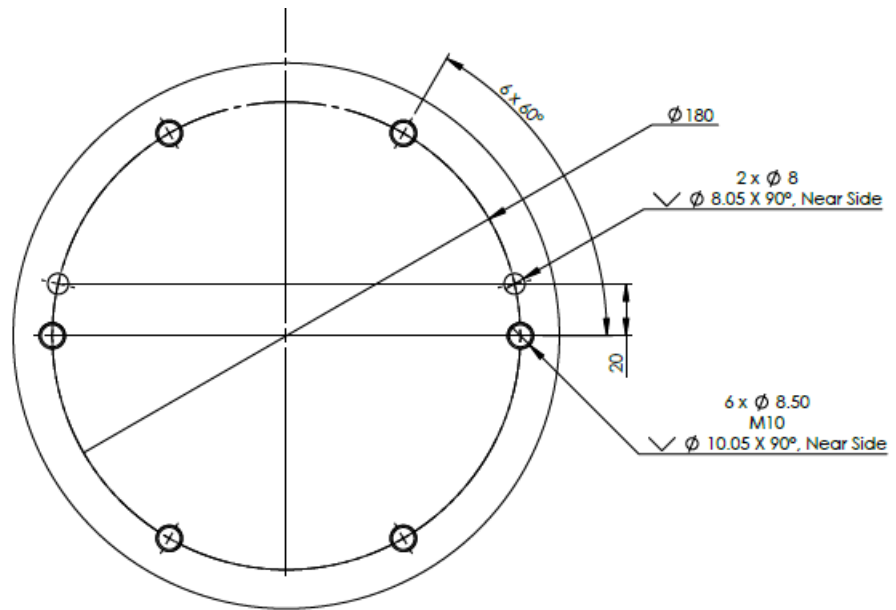

1.1: Bottom view of Robot base

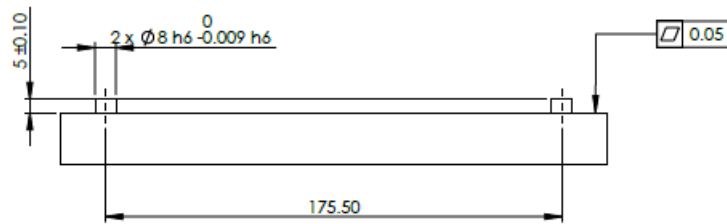

1.2: Mounting plate for Robot base

**To power down the robot arm****WARNING**

Unexpected startup and/or movement can lead to injury.

- Power down the robot arm to prevent unexpected startup during mounting and dismounting.

1. On the left side of the footer, tap the **Robot State** icon to turn off the robot arm.  
The icon color changes from green to white.
2. Press the power button on the Teach Pendant to turn off the Control Box.
3. If a **Shutdown** dialog box appears, tap **Power Off**.

You can now:

- Unplug the mains cable/power cord from the wall socket.
- Wait 30 seconds for the robot to discharge any stored energy.

**To secure the robot arm**

1. Place the robot arm on the surface on which it is to be mounted.  
The surface must be even and clean.
2. Tighten the six 8.8 strength, M10 bolts to a torque of 45 Nm.  
(Torque values have been updated SW 5.18. Earlier printed version will show different values)
3. If accurate re-mounting of the robot is required, use the Ø8 mm. hole and Ø8x13 mm. slot with corresponding ISO 2338 Ø8 h6 positioning pins in the mounting plate.

## 6.2. Dimensioning the Stand

**Description** The structure (stand) on which the robot arm is mounted is a crucial part of the robot installation. The stand must be sturdy and free of any vibrations from external sources.

Each robot joint produces a torque that moves and stops the robot arm. During normal uninterrupted operation and during stopping motion, the joint torques are transferred to the robot stand as:

- $M_z$ : Torque around the base z axis.
- $F_z$ : Forces along base z axis.
- $M_{xy}$ : Tilting torque in any direction of the base xy plane.
- $F_{xy}$ : Force in any direction in the base xy plane.

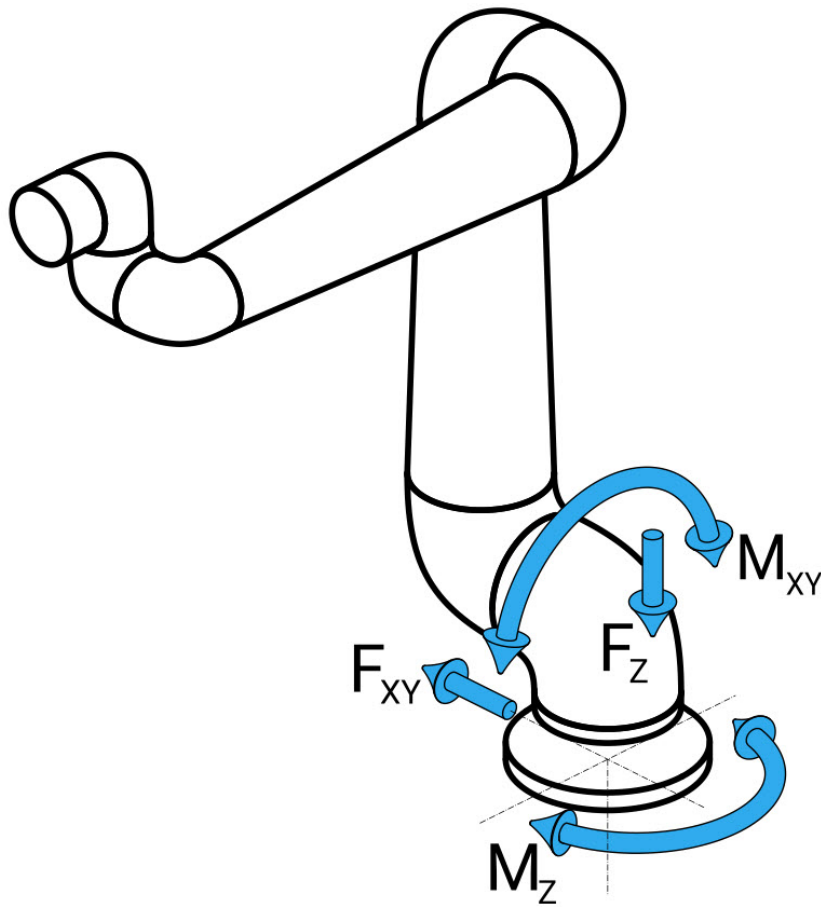

*Force and moment at base flange definition.*

**Dimensioning the Stand** The magnitude of the loads depends on robot model, program and multiple other factors. Dimensioning of the stand shall account for the loads that the robot arm generates during normal uninterrupted operation and during category 0, 1 and 2 stopping motion. During stopping motion, the joints are allowed to exceed the maximum nominal operating torque. The load during stopping motion is independent of the stop category type. The values stated in the following tables are maximum nominal loads in worst-case movements multiplied with a safety factor of 2.5. The actual loads will not exceed these values.

Robot Model	Mz [Nm]	Fz[Nm]	Mxy[Nm]	Fxy [Nm]
UR18	1310	2600	1740	2000

*Maximum joint torques during category 0, 1 and 2 stops.*

Robot Model	Mz [Nm]	Fz[Nm]	Mxy[Nm]	Fxy [Nm]
UR18	1090	2020	1500	1630

*Maximum joint torques during normal operation.*

The normal operating loads can generally be reduced by lowering the acceleration limits of the joints. Actual operating loads are dependent on the application and robot program. You can use URSim to evaluate the expected loads in your specific application.

**Safety margin** You can incorporate added safety margins, factoring in the following design considerations:

- **Static stiffness:** A stand that is not sufficiently stiff will deflect during robot motion, resulting in the robot arm not hitting the intended waypoint or path. Lack of static stiffness can also result in a poor freedrive teaching experience or protective stops.
- **Dynamic stiffness:** If the frequency of the stand matches the movement frequency of the robot arm, the entire system can resonate, creating the impression that the robot arm is vibrating. Lack of dynamic stiffness can also result in protective stops. The stand should have a minimum resonance frequency of 45 Hz.
- **Fatigue:** The stand shall be dimensioned to match the expected operating lifetime and load cycles of the complete system.



#### WARNING

- Potential for tip-over Hazards.
- The robot arm's operational loads can cause movable platforms, such as tables or mobile robots, to tip over, resulting in possible accidents.
- Prioritize safety by implementing adequate measures to prevent the tipping of movable platforms at all times.



#### CAUTION

- If the robot is mounted on an external axis, the accelerations of this axis must not be too high.

You can let the robot software compensate for the acceleration of external axes by using script command:

```
set_base_acceleration()
```

- High accelerations can cause the robot to make safety stops.

## 6.3. Mounting Description

### Description

Tool (Tool Flange)	Uses four M6 thread holes for attaching a tool to the robot. The M6 bolts shall be tightened with 8 Nm, strength class 8.8. For accurate tool repositioning, use a pin in the Ø6 hole provided.
Control Box	The Control Box can be hung on a wall or placed on the ground.
Teach Pendant	The Teach Pendant is wall mounted or placed onto the Control Box. Verify the cable does not cause tripping hazard. You can buy extra brackets for mounting the Control Box and Teach Pendant.



#### WARNING

Mounting and operating the robot in environments exceeding the recommended IP rating can result in injury.

- Mount the robot in an environment suited to the IP rating. The robot must not be operated in environments that exceed those corresponding to the IP ratings of the robot arm (IP65), Teach Pendant (IP54) and Control Box (IP44)



#### WARNING

Unstable mounting can result in injury.

- Always make sure the robot parts are properly and securely mounted and bolted in place.

### 6.3.1. Control Box Mounting

**To mount a  
CB to a wall**

Use the bracket, shown below, included with the robot to mount the Control Box.  
Mount the bracket to a wall, then hang the Control Box on the bracket via the mounting  
pegs.

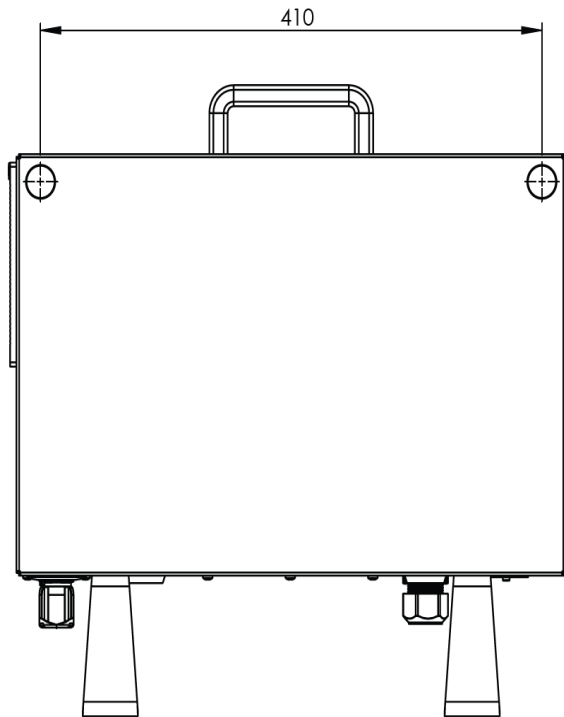
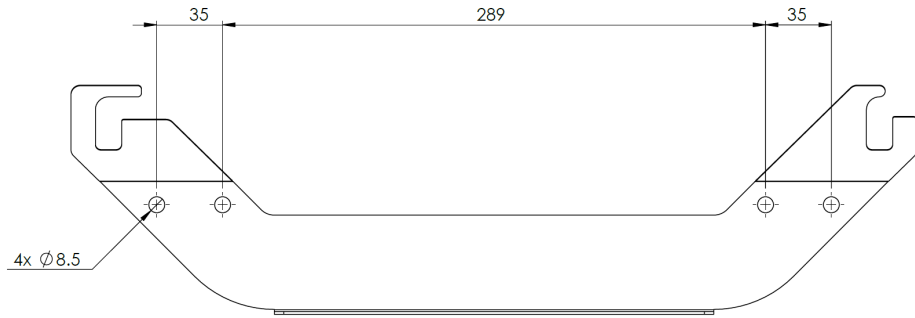

## 6.3.2. Control Box Clearance

---

### Description

The flow of hot air in the Control Box can result in equipment malfunction. The recommended Control Box clearance is 200 mm on each side for sufficient cool airflow.

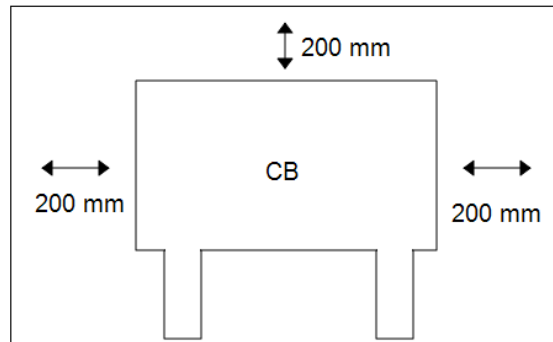

### WARNING

A wet Control Box can cause fatal injury.

- Make sure the Control Box and cables do not come into contact with liquids.
- Place the Control Box (IP44) in an environment suited for the IP rating.

## 6.4. Workspace and Operating Space

---

**Description** The workspace is the range of the fully extended robot arm, horizontally and vertically. The operating space is the location where the robot is expected to function.



**NOTICE**

Disregard for the robot workspace and operating space can result in the damage to property.

It is important to consider the cylindrical volume directly above and directly below the robot base when choosing location to mount the robot. Moving the tool close to the cylindrical volume should be avoided because it causes the joints to move fast even when the tool is moving slowly. This can cause the robot to work inefficiently and can make it difficult to conduct a risk assessment.



**NOTICE**

Moving the tool close to the cylindrical volume can cause the joints to move too fast, leading to loss of functionality and damage to property.

- Do not move the tool close to the cylindrical volume, even when the tool is moving slowly.

The cylindrical volume is both directly above and directly below the robot base. The robot extends 950 mm from the base joint.

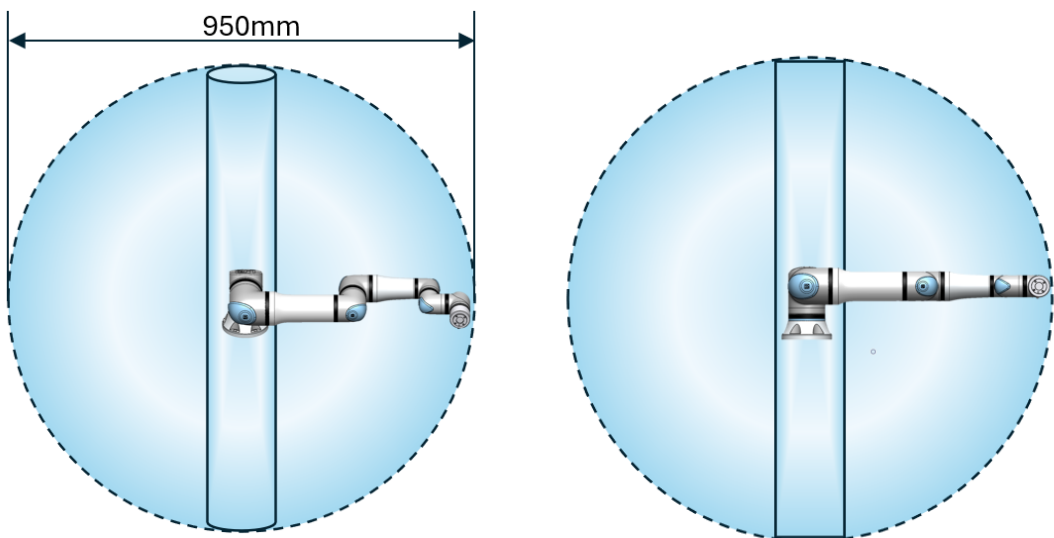

Front

Tilted

### 6.4.1. Singularity

**Description**

A singularity is a pose that restricts the motion and the ability to position the robot. The robot arm can stop moving or have very sudden and fast movements when approaching and leaving singularity. During placement of robot in the workspace and definition of the operating space, it is important to take into consideration the singularity position detailed below.

**WARNING**

Make sure that robot motion near a singularity does not create hazards to anyone within the range of the robot arm, end effector, and workpiece.

- Set safety limits for the speed and acceleration of the elbow joint.

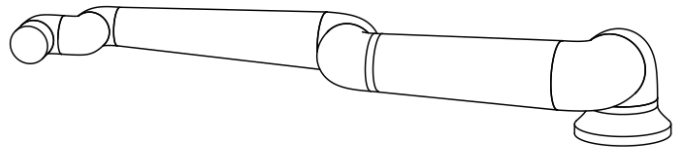
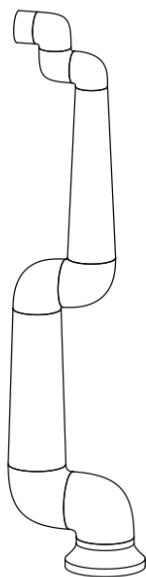

The following causes singularity in the robot arm:

- Outer workspace limit
- Inner workspace limit
- Wrist alignment

**Outer workspace limit**

The singularity occurs because the robot cannot reach far enough or it reaches outside of the maximum working area.

To avoid: Arrange the equipment around the robot to avoid it reaching outside of the recommended workspace.

**Inner workspace limit**

The singularity occurs because the movements are directly above or directly below the robot base. This causes many positions/orientations to be unreachable.

To avoid: Program the robot task in such a way that it is not necessary to work in or close to the central cylinder. You can also consider mounting the robot base on a horizontal surface to rotate the central cylinder from a vertical to horizontal orientation, potentially moving it away from the critical areas of the task.

---

**Wrist alignment**

This singularity occurs because wrist joint 2 rotates on the same plane as the shoulder, elbow and wrist joint 1. This limits the range of movement of the robot arm, regardless of workspace.

To avoid: Layout the robot task in such a way that it is not necessary to align the robot wrist joints in this manner. You can also offset the direction of the tool, so that the tool can point horizontally without the problematic wrist alignment.

---

## 6.4.2. Fixed and Movable Installation

---

**Description**

Whether the robot arm is fixed (mounted to a stand, wall or floor) or in a movable installation (linear axis, push cart, or mobile robot base), it must be installed securely to ensure stability through all motions.

The design of the mounting must ensure stability when there are movements of:

- the robot arm
  - the robot base
  - both robot arm and robot base
-

## 6.5. Robot Connections: Base Flange Cable

---

**Description** This subsection describes the connection for a robot arm configured with a Base Flange Cable connector.

---

**Base Flange Cable connector** The Base Flange Cable establishes the robot connection to the robot arm to the Control Box. The Robot Cable connects to the Base Flange Cable connector on one end, and to the Control Box connector on the other end.  
You can lock each connector when robot connection is established.



### CAUTION

Improper robot connection can result in loss of power to the robot arm.

- Do not use one Robot Cable to extend another Robot Cable.



### NOTICE

Connecting the Base Flange Cable directly to any Control Box can result in equipment or property damage.

- Do not connect the Base Flange Cable directly to the Control Box.
-

## 6.6. Robot Connections: Robot Cable

**Description** This subsection describes the connection for a robot arm configured with a fixed 6 meter Robot Cable.

**To connect the arm and Control box** You can turn the connector to the right to make it easier to lock after the cable is plugged in.

- Establish the robot connection by connecting the robot arm to the Control Box with the Robot Cable.
- Plug and lock the cable from the robot into the connector at the bottom of the Control Box shown below.
- Twist the connector twice to ensure it is properly locked before turning on the robot arm.



### CAUTION

Improper robot connection can result in loss of power to the robot arm.

- Do not disconnect the Robot Cable when the robot arm is turned on.
- Do not modify the original Robot Cable.

## 6.7. Mains Connections

### Description

The mains cable from the Control Box has a standard IEC plug at the end. Connect a country specific mains plug, or cable, to the IEC plug.



#### NOTICE

- IEC 61000-6-4:Chapter 1 scope: “This part of IEC 61000 for emission requirement applies to electrical and electronic equipment intended for use within the environment of existing at industrial (see 3.1.12) locations.”
- IEC 61000-6-4:Chapter 3.1.12 industrial location: “Locations characterized by a separate power network, supplied from a high- or medium-voltage transformer, dedicated for the supply of the installation”

### Mains connections

To power the robot, the Control Box shall be connected to the mains via the supplied power cord. The IEC C13 connector on the power cord connects to the IEC C14 appliance inlet at the bottom of the Control Box.



#### WARNING: ELECTRICITY

Failure to correctly place the mains connection can result in injury.

- The power plug for the mains connection shall be placed outside the reach of the robot, such that power can be removed without exposing personnel to potential hazards.
- If additional safeguarding is implemented, the power plug for the mains connection shall also be placed outside the safeguarded space such that power can be removed without exposure to any potential hazards.



#### NOTICE

Always use a power cord with a country specific wall plug when connecting to the Control Box.

For <200 Vac countries, use power cord with 15A ampacity.

For >200 Vac countries, use power cord with 10A ampacity.

Do not use an adapter.

As a part of the electrical installation, provide the following:

- Connection to ground
- Main fuse
- Residual current device
- A lockable (in the OFF position) switch

A main switch shall be installed to power off all equipment in the robot application as an easy means for lockout. The electrical specifications are shown in the table below.

Parameter	Min	Typ	Max	Unit
Input voltage	90	-	264	VAC
External mains fuse (90-200V)		-	16	A
External mains fuse (200-264V)	8	-	16	A
Input frequency	47	-	440	Hz
Stand-by power	-	-	<1.5	W
Nominal operating power	90			W



**WARNING: ELECTRICITY**

Failure to follow any of the below can result in serious injury or death due to electrical hazards.

- Ensure the robot is grounded correctly (electrical connection to ground). Use the unused bolts associated with grounding symbols inside the Control Box to create common grounding of all equipment in the system. The grounding conductor shall have at least the current rating of the highest current in the system.
- Ensure the input power to the Control Box is protected with a Residual Current Device (RCD) and a correct fuse.
- Lockout all power for the complete robot installation during service.
- Ensure other equipment shall not supply power to the robot I/O when the robot is locked out.
- Ensure all cables are connected correctly before the Control Box is powered. Always use the original power cord.

## 7. First Boot

---

### Description

The first boot is the initial sequence of actions you can take with the robot after assembly. This initial sequence requires you to:

- Power on the robot
  - Insert the serial number
  - Initialize the robot arm
  - Power down the robot
- 



#### CAUTION

Failure to verify the payload and installation before starting up the robot arm can lead to injury to personnel and/or property damage.

- Always verify the actual payload and installation are correct before starting up the robot arm.



#### CAUTION

Incorrect payload and installation settings prevent the robot arm and Control Box in functioning correctly.

- Always verify the payload and installation setting are correct.



#### NOTICE

Starting up the robot in lower temperature can result in lower performance, or stops, due to temperature-dependent oil and grease viscosity.

- Starting up the robot in low temperatures can require a warmup phase.
-

## 7.1. Powering On the Robot

- To power on the robot**      Powering on the robot turns on the Control Box and loads the display on the TP screen.
1. Press the power button on the Teach Pendant to power on the robot.

## 7.2. Inserting the Serial Number

- To insert the serial number**      Installing your robot for the first time requires you to enter the serial number on the robot arm. This procedure is also required when you re-install the software. For example, when you install a software update.
1. Select your Control Box.
  2. Add the serial number as it is written on the robot arm.
  3. Tap **OK** to end.

It can take a few minutes for the start screen to load.



### Select Control Box

Standard

OEM AC

OEM DC

### Enter Serial Number

\_\_\_\_\_

1 2 3

4 5 6

7 8 9

0

## 7.3. Starting the Robot Arm

### To start the robot

Starting the robot arm disengages the braking system, allowing you to start moving the robot arm and to start using PolyScope X.

1. In the left side of the footer, tap the power button or **Robot State** icon. The robot arm state is **Off**.
2. When the Initialize box displays, tap **Power On**. The robot arm state is **Booting**.

#### Initialize

##### Arm - OFF

Robot arm is currently off and not communicating with the controller.

Press "**Power On**" to send power to the arm in a locked state.

Active Payload  
0.000 kg
Application Payload | 0 kg

 **Power On**



Robot State

**Off**

3. Tap **Unlock** to release the brakes.

#### Initialize

##### Arm - LOCKED

The robot arm is powered but for safety has its brakes applied.

Confirm that the below payload is accurate before unlocking.

Active Payload  
0.000 kg
Application Payload | 0 kg

 **Power Off**

 **Unlock**



Robot State

**Locked**

Robot arm initialization is accompanied by sound and slight movements as the joint brakes are released.

- The robot arm state is now **Active**, and you can start to use the interface.

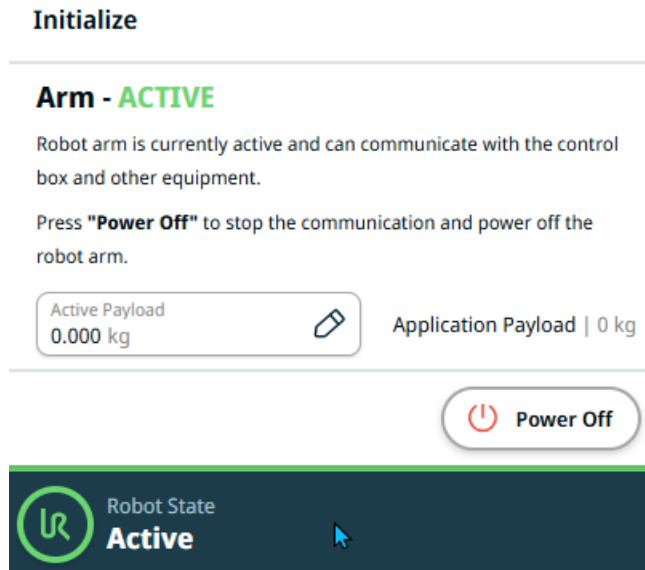

- You can tap **Power Off** to turn off the robot arm.

When the robot arm state changes from **Idle** to **Normal**, sensor data is checked against the configured mounting of the robot arm.

If the mounting is verified, tap **START** to continue releasing all joint brakes, preparing the robot arm for operation.

## 7.4. Powering Down the Robot

To power down the robot arm



### WARNING

Unexpected startup and/or movement can lead to injury.

- Power down the robot arm to prevent unexpected startup during mounting and dismounting.

- On the left side of the footer, tap the **Robot State** icon to turn off the robot arm. The icon color changes from green to white.
- Press the power button on the Teach Pendant to turn off the Control Box.
- If a **Shutdown** dialog box appears, tap **Power Off**.

You can now:

- Unplug the mains cable/power cord from the wall socket.
- Wait 30 seconds for the robot to discharge any stored energy.

## 7.5. Application Tab

The Application tab allows you to configure the settings which affect the overall performance of the robot and PolyScope X.

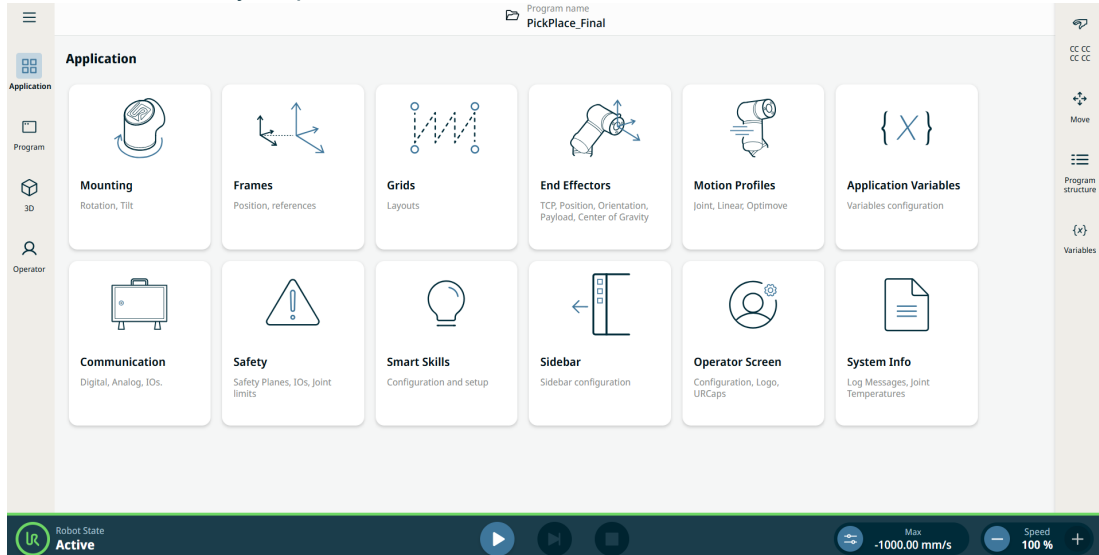

Figure 1.3: Application screen displaying application buttons.

Use the Application tab to access to the following configuration screens.

- Mounting
- Frames
- Grids Application
- End Effectors Application
- Motion Profiles
- Application Variables
- Communication
- Safety
- Smart Skills Application
- Sidebar in the Application Tab
- Operator Screen Application
- System Info

## 7.6. Move the Robot with 3PE Teach Pendant

**Description** Freedrive allows the robot arm to be manually pulled into desired positions. For most robot sizes, the most typical way to enable Freedrive is to press the Freedrive button on the Teach Pendant. More ways to enable and use Freedrive are described in the following sections. In Freedrive, the robot arm joints move with little resistance because the brakes are released. Resistance increases as the robot arm in Freedrive approaches a predefined limit or plane. This makes pulling the robot into position feel heavy.

**WARNING**

Injury to personnel can occur due to unexpected motion.

- Verify the configured payload matches the payload in use.
- Verify the correct payload is securely attached to the tool flange.

**Enabling Freedrive**

You can enable Freedrive in the following ways:

- Use the 3PE Teach Pendant.
- Use the Freedrive on robot.
- Use I/O actions.

**NOTICE**

Enabling Freedrive while you are moving the robot arm can cause drift and faults.

- Do not enable Freedrive while you are pushing or touching the robot.

**3PE Teach Pendant**

To use the 3PE TP button to freedrive the robot arm:

1. Rapidly light-press, release, light-press again and keep holding the 3PE button in this position.

Now you can pull the robot arm into a desired position, while the light-press is maintained.

**Freedrive on robot**

Use **Freedrive on robot** to move the robot arm in PolyScope:

1. On the main navigation, tap **Application**, and then tap **Safety**.
2. Tap **Unlock** and enter the password.
3. Under Safety I/O, tap **Inputs**.
4. On the **Functions** drop-down menu, scroll down to **Freedrive Enabled Input**.
5. Tap **Apply** and **Apply and Restart** to restart the robot arm.
6. Tap **Confirm Configuration**.
7. Move the robot arm as desired.

**Backdrive** During initialization of the robot arm, minor vibrations may be observed when the robot brakes are released. In some situations, such as when the robot is close to collision, these vibrations are undesirable. Use Backdrive to force specific joints to a desired position without releasing all brakes in the robot arm.

---

**Heavy  
Freedrive** If the robot arm is powered on and the brakes are released, the joints can be moved by force. The force required to initiate motion depends on the Force Limits specified in the safety settings.

---

# 8. Installation

**Description** Installing the robot can require the configuration and use of input and output signals (I/Os). These different types of I/Os and their uses are described in the following sections.

## 8.1. Electrical Warnings and Cautions

**Warnings** Observe the following warnings for all the interface groups, including when you design and install an application.



### WARNING

Failure to follow any of the below can result in serious injury or death, as the safety functions could be overridden.

- Never connect safety signals to a PLC that is not a safety PLC with the correct safety level. It is important to keep safety interface signals separated from the normal I/O interface signals.
- All safety-related signals shall be constructed redundantly (two independent channels).
- Keep the two independent channels separate so a single fault cannot lead to loss of the safety function.



### WARNING: ELECTRICITY

Failure to follow any of the below can result in serious injury or death due to electrical hazards.

- Make sure all equipment not rated for water exposure remain dry. If water is allowed to enter the product, lockout-tagout all power and then contact your local Universal Robots service provider for assistance.
- Only use the original cables supplied with the robot only. Do not use the robot for applications where the cables are subject to flexing.
- Use caution when installing interface cables to the robot I/O. The metal plate in the bottom is intended for interface cables and connectors. Remove the plate before drilling holes. Make sure that all shavings are removed before reinstalling the plate. Remember to use correct gland sizes.

**CAUTION**

Disturbing signals with levels higher than those defined in the specific IEC standards can cause unexpected behaviors from the robot. Be aware of the following:

- The robot has been tested according to international IEC standards for **ElectroMagnetic Compatibility (EMC)**. Very high signal levels or excessive exposure can damage the robot permanently. EMC problems are found to happen usually in welding processes and are normally prompted by error messages in the log. Universal Robots cannot be held responsible for any damages caused by EMC problems.
- I/O cables going from the Control Box to other machinery and factory equipment may not be longer than 30m, unless additional tests are performed.

**GROUND**

Negative connections are referred to as Ground (GND) and are connected to the casing of the robot and the Control Box. All mentioned GND connections are only for powering and signalling. For PE (Protective Earth) use the M6-size screw connections marked with earth symbols inside the Control Box. The grounding conductor shall have at least the current rating of the highest current in the system.

**READ MANUAL**

Some I/Os inside the Control Box can be configured for either normal or safety-related I/O. Read and understand the complete Electrical Interface chapter.

## 8.2. Control Box Connection Ports

### Description

The underside of the I/O interface groups in the Control Box is equipped with external connection ports and a fuse, described below. There are capped openings at the base of the Control Box cabinet to run external connector cables to access the connection ports.

### External connection ports

The ports for external connections are as follows:

- Teach Pendant port to use the Teach Pendant to control or program the robot arm.
- SD card port to insert an SD card.
- Ethernet port to allow ethernet type connections.
- Mini DisplayPort to support monitors using DisplayPort. This port requires an active converter to support DVI or HDMI.
- The Mini Blade Fuse is used when an external power supply is connected.

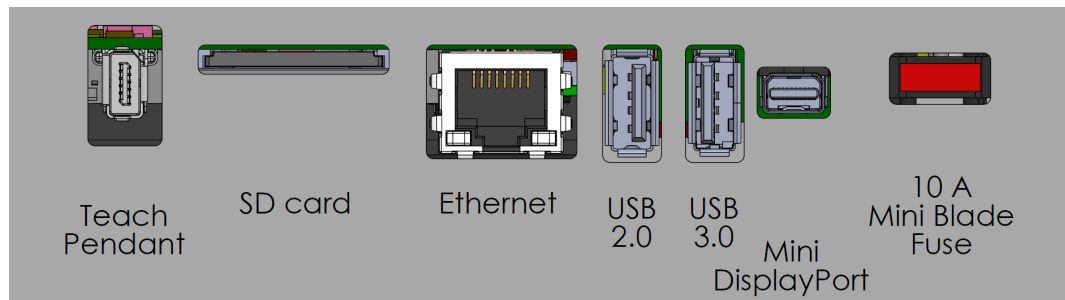

#### NOTICE

Connecting or disconnecting a Teach Pendant while the Control Box is powered on can cause equipment damage .

- Do not connect a Teach Pendant while the Control Box is on.
- Power off the Control Box before you connect a Teach Pendant.



#### NOTICE

Failure to plug in the active adapter before powering on the Control Box can hinder the display output.

- Plug in the active adapter before powering on the Control Box.
- In some cases the external monitor must be powered on before the Control Box.
- Use an active adapter that supports revision 1.2 as not all adapters function out-of-the-box.

## 8.3. Ethernet

- Description** The Ethernet interface can be used for:
- MODBUS, EtherNet/IP and PROFINET.
  - Remote access and control.

To connect the Ethernet cable by passing it through the hole at the base of the Control Box, and plugging it into the Ethernet port on the underside of the bracket. Replace the cap at the base of the Control Box with an appropriate cable gland to connect the cable to the Ethernet port.

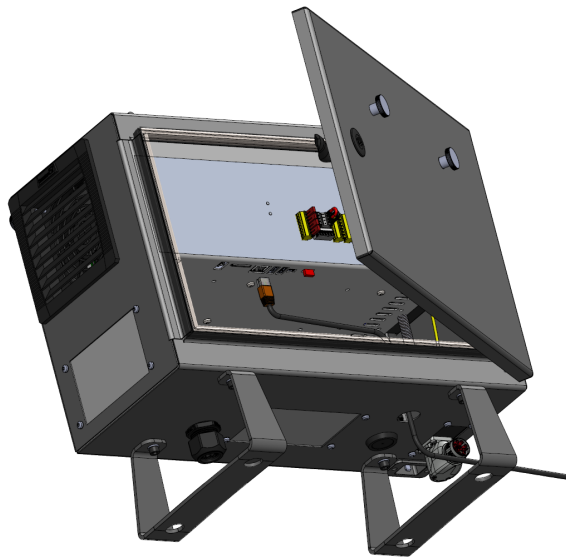

The electrical specifications are shown in the table below.

Parameter	Min	Typ	Max	Unit
Communication speed	10	-	1000	Mb/s

## 8.4. 3PE Teach Pendant Installation

**Description** The 3-Position Enabling Teach Pendant (3PE TP) is a safety-critical interface designed to enhance manual control. Integrated directly into the Teach Pendant, the 3PE buttons ensure that robot motion can only be initiated when the operator maintains a controlled grip.

### 8.4.1. Hardware Installation

#### To remove a Teach Pendant



**NOTICE**

Replacing the Teach Pendant can result in the system reporting a fault on start-up.

- Always select the correct configuration for the type of Teach Pendant.

To remove the standard Teach Pendant:

1. Power down the control box and disconnect the main power cable from the power source.
2. Remove and discard the two cable ties used for mounting the Teach Pendant cables.
3. Press in the clips on both sides of the Teach Pendant plug as illustrated, and pull down to disconnect from the Teach Pendant port.
4. Fully open/loosen the plastic grommet at the bottom of the control box and remove the Teach Pendant plug and cable.
5. Gently remove the Teach Pendant cable and Teach Pendant.

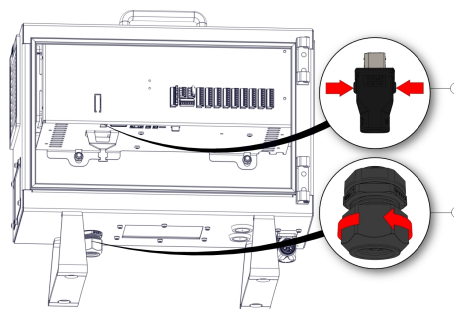

1 Clips

2 Plastic grommet

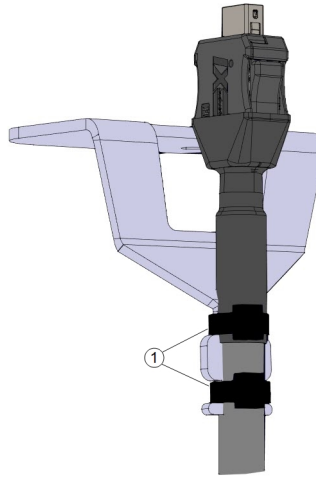

1	Cable ties
---	------------

### To install a 3PE Teach Pendant

1. Place the Teach Pendant plug and cable in through the bottom of the control box and fully close/tighten the plastic grommet.
2. Push the Teach Pendant plug into the Teach Pendant port to connect.
3. Use two new cable ties to mount the Teach Pendant cables.
4. Connect the main power cable to the power source and power on the control box.

There is always a length of cable with the Teach Pendant that can present a tripping hazard if it is not stored properly.

- Always store the Teach Pendant and the cable properly to avoid tripping hazards.

## 8.4.2. Software Installation

To configure the 3PE TP software

1. On PolyScope, in the left menu, tap **Application** and select **Safety**.

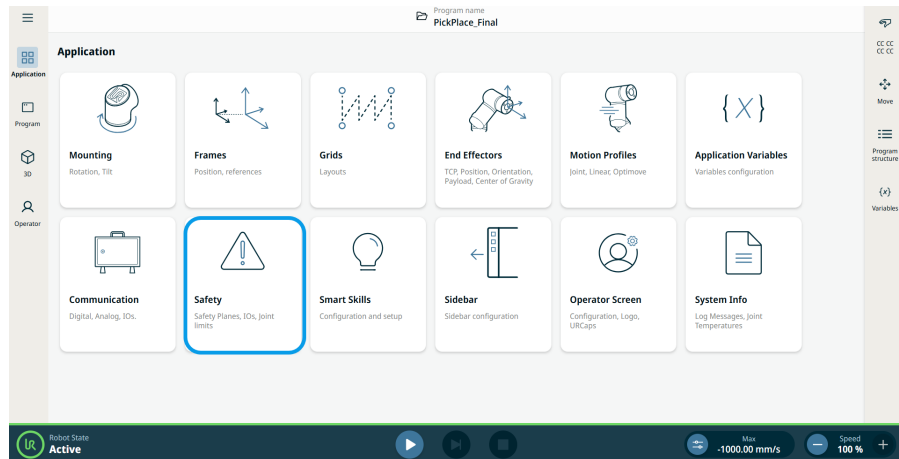

2. Tap **Hardware** and the **Unlock** button.

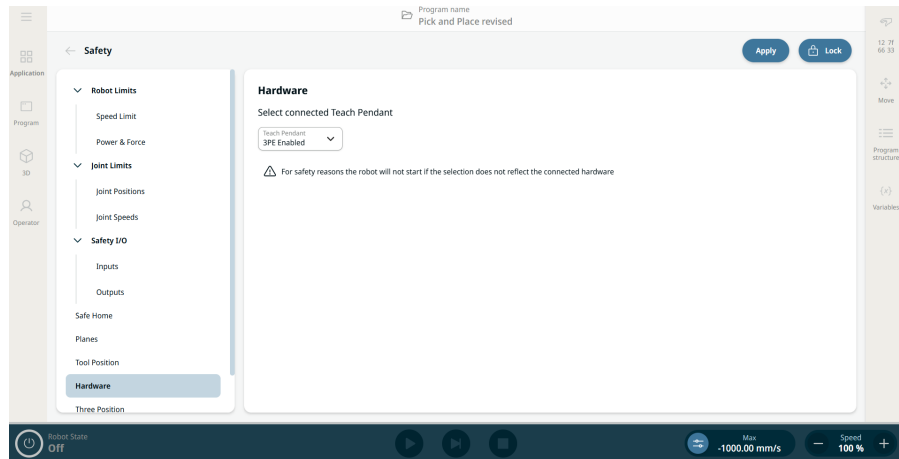

3. Enter the password and tap **Confirm**. Teach Pendant is now enable.
4. Tap **Apply** to restart the system. PolyScope continues to run.
5. Tap **Apply and restart** then **Confirm Configuration** to complete the 3PE Teach Pendant software installation.

## 8.5. Controller I/O

**Description** The electrical interface inside the Control Box consists of groups Inputs and Outputs I/O that allow for communication and configurations between the robot arm and different types of equipment. The I/O groups include:

- Digital (24V)
- Configurable (24V)
- Analog
- Safety (24V)

The illustration below shows the layout of electrical interface groups inside the Control Box. Observe and maintain the purpose of the color scheme, as illustrated below.

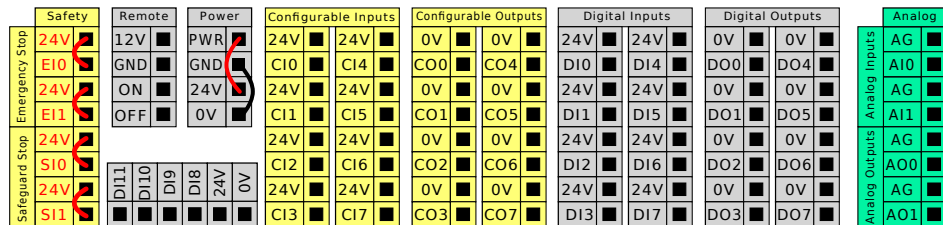

Yellow with red text	Dedicated safety signals
Yellow with black text	Configurable for safety
Gray with black text	General purpose digital I/O
Green with black text	General purpose analog I/O

**I/O groups** You can install the robot according to the electrical specifications which are the same for all three listed inputs.

- Safety I/O.
- Configurable I/O.
- General purpose I/O.



**NOTICE**

Configurable I/O are I/O configured as either safety-related I/O or normal I/O. These are the yellow terminals with black text.

It is possible to power the digital I/O from an internal 24V power supply or from an external power source by configuring the terminal block called **Power**. This block consists of four terminals. The upper two (PWR and GND) are 24V and ground from the internal 24V supply. The lower two terminals (24V and 0V) in the block are the 24V input to supply the I/O. The default configuration uses the internal power supply.

**Power supply default** In this example the default configuration uses the internal power supply

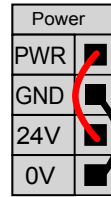

**External power supply** If more current is needed, you can connect an external power supply as shown below. The fuse is Mini Blade type with maximum current rating of 10 A and a minimum voltage rating of 32 V. The fuse must be UL marked. If the fuse is overloaded, it must be replaced.

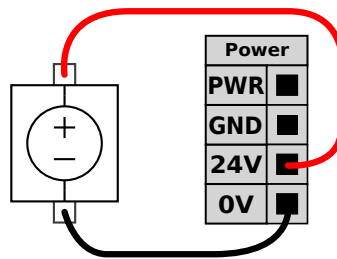

In this example the configuration uses an external power supply for more current.

**Power supply specification** The electrical specifications for both the internal and external power supply are shown below.

Terminals	Parameter	Min	Typ	Max	Unit
<i>Internal 24V power supply</i>					
[ PWR - GND ]	Voltage	23	24	25	V
[ PWR - GND ]	Current	0	-	2*	A
<i>External 24V input requirements</i>					
[ 24V - 0V ]	Voltage	20	24	29	V
[ 24V - 0V ]	Current	0	-	6	A

\*3.5A for 500ms or 33% duty cycle.

**Digital I/O  
specification**

The digital I/O are constructed in compliance with IEC 61131-2. The electrical specifications are shown below.

Terminals	Parameter	Min	Typ	Max	Unit
<i>Digital Outputs</i>					
[CO <sub>x</sub> / DO <sub>x</sub> ]	Current*	0	-	1	A
[CO <sub>x</sub> / DO <sub>x</sub> ]	Voltage drop	0	-	0.5	V
[CO <sub>x</sub> / DO <sub>x</sub> ]	Leakage current	0	-	0.1	mA
[CO <sub>x</sub> / DO <sub>x</sub> ]	Function	-	PNP	-	Type
[CO <sub>x</sub> / DO <sub>x</sub> ]	IEC 61131-2	-	1A	-	Type
<i>Digital Inputs</i>					
[EI <sub>x</sub> /SI <sub>x</sub> /CI <sub>x</sub> /DI <sub>x</sub> ]	Voltage	-3	-	30	V
[EI <sub>x</sub> /SI <sub>x</sub> /CI <sub>x</sub> /DI <sub>x</sub> ]	OFF region	-3	-	5	V
[EI <sub>x</sub> /SI <sub>x</sub> /CI <sub>x</sub> /DI <sub>x</sub> ]	ON region	11	-	30	V
[EI <sub>x</sub> /SI <sub>x</sub> /CI <sub>x</sub> /DI <sub>x</sub> ]	Current (11-30V)	2	-	15	mA
[EI <sub>x</sub> /SI <sub>x</sub> /CI <sub>x</sub> /DI <sub>x</sub> ]	Function	-	PNP +	-	Type
[EI <sub>x</sub> /SI <sub>x</sub> /CI <sub>x</sub> /DI <sub>x</sub> ]	IEC 61131-2	-	3	-	Type

\*For resistive loads or inductive loads of maximum 1H.

### 8.5.1. Digital Input and Output

**Tool Output**

The tool output contains two digital output fields, tool output voltage and power supply current indicator and Dual Pin Power toggle.

- **Digital Output (DO)** - can be independently set to high or low
- **Tool Output Voltage** - selectable 0V, 12V and 24V. This setting is persistent over restarts of the robot controller
- **Power Supply** - current consumption indicator
- **Dual Pin Power** - used to toggle between digital outputs and source of power for the tool. Enabling Dual Pin Power disables the default tool digital outputs (DO)

After selecting a new output configuration, the changes take effect. The currently loaded installation is modified to reflect the new configuration. After verifying the tool outputs are working as intended, make sure to save the installation to prevent losing changes.

**Digital Input** You can use the horizontal Digital Inputs block (DI8-DI11), illustrated below, for quadrature encoding Conveyor Tracking.

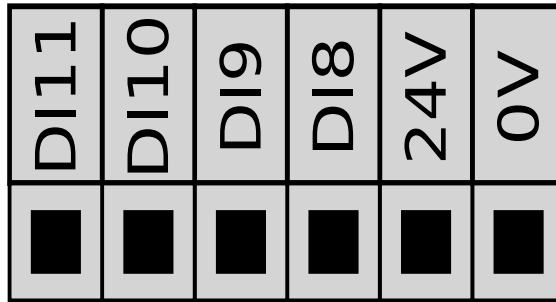

## 8.5.2. Using the Wired I/O Tab

### Description

Use the Wired I/O Tab screen to monitor and set the live I/O signals from/to the Control Box.

The screen displays the current state of the I/O, including during program execution. The program stops if anything is changed during execution. At program stop, all output signals retain their states. The screen updates at 10Hz, so a very fast signal might not display properly.

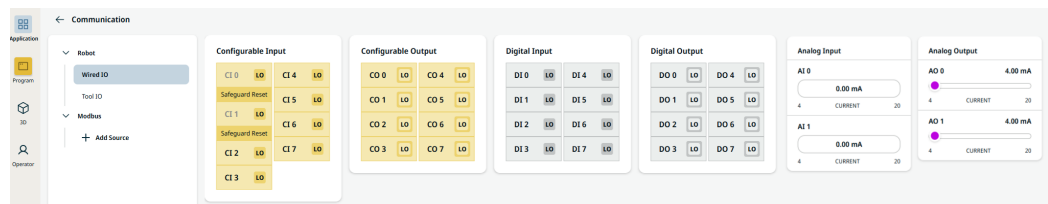

### Configurable I/Os

Configurable I/Os can be reserved for special safety settings defined in the I/O Setup. Under those which are reserved will have the name of the safety function in place of the default or user defined name.

Configurable inputs that are reserved for safety settings are not toggable and will be displayed as LED's only.

For unreserved I/Os, it has the following options:

- Start Program
- Stop Program
- Pause Program
- Freedrive

### Digital I/Os

DI have the following options:

- Start Program
- Stop Program
- Pause Program
- Freedrive

All DIs are preset to Low.

All DOs are set independently to either high or low.

### Analog IOs

The analog I/O's can be set to either current [4-20mA] or voltage [0-10V] output. These settings are persistent over restarts of the robot controller and saved in the installation.

### 8.5.3. Drive Power Indicator

**Description** The drive power indicator is a light that turns on when the robot arm is powered on, or when there is power to the robot cable. When the robot arm is powered off, the drive power indicator turns off.

The drive power indicator is connected via the Digital Outputs. It is not a safety feature and does not use safety I/Os.

**Indicator** The drive power indicator can be a light that can work at 24VDC.

**To set up the indicator** Setting up the indicator requires a light and wiring for the outputs.

1. Connect your drive power indicator to the Digital Outputs as shown in the image below.
2. Verify the drive power indicator is correctly connected.
  - You can power on the robot arm and verify the light turns on.
  - You can power off the robot arm and verify the light turns off.

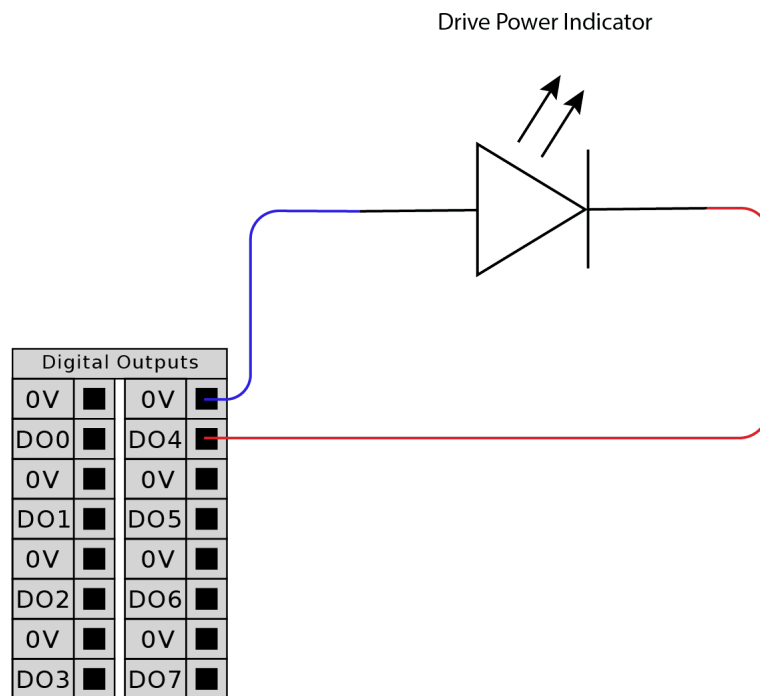

**To configure the indicator**

1. In the Navigation menu, tap **Application**.
2. Select **Communication**.
3. In the side menu, select **Wired IO**.
4. Scroll to your desired output type and tap to select one of the following:
  - Configurable Output
  - Digital Output
  - Analog Output
5. Select **Action Preset**  
You can name the selected output
6. In the dropdown select **High when drive power is on, otherwise Low**.

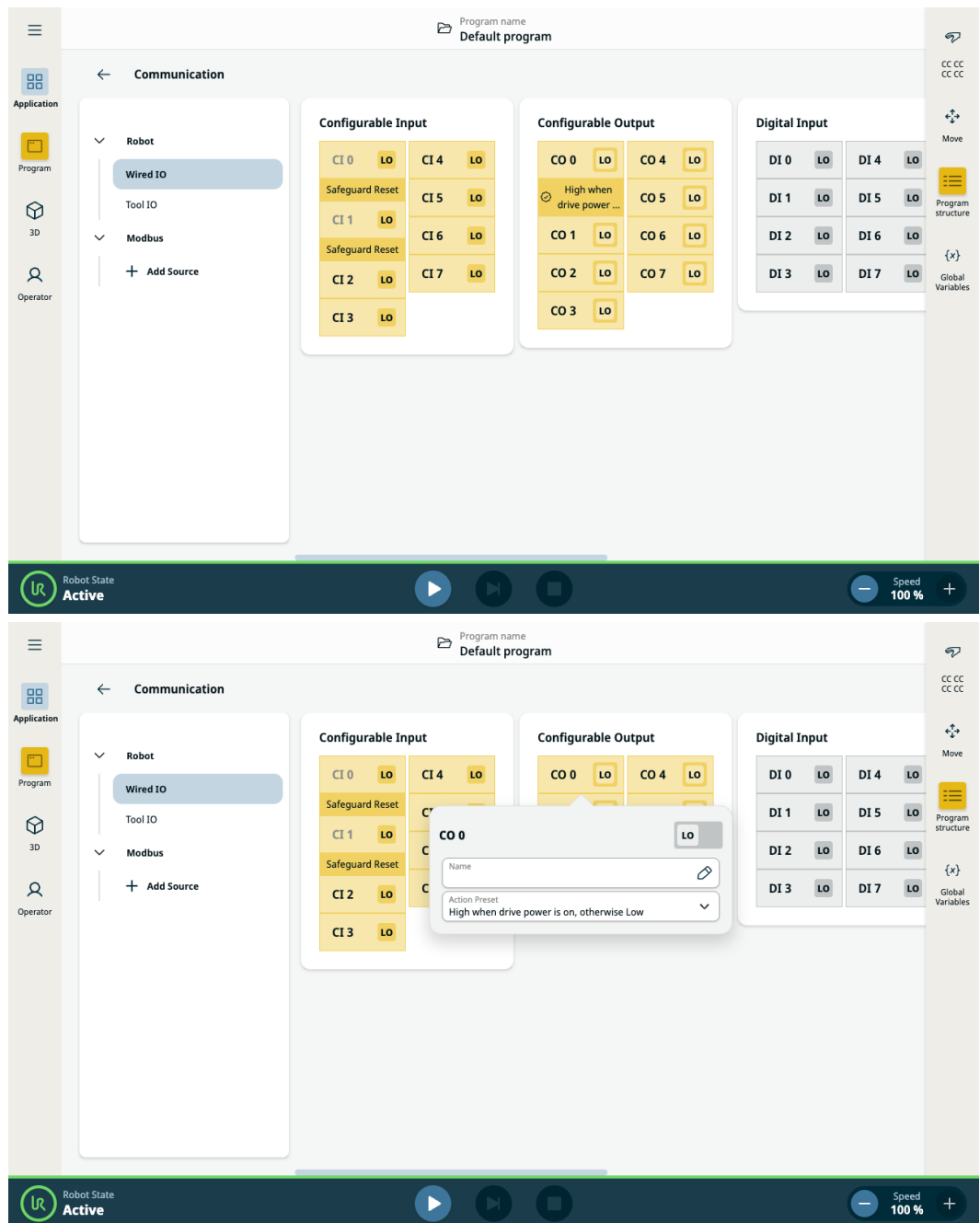

Copyright © 2009-2026 by Universal Robots A/S. All rights reserved.

## 8.6. Safety I/O

**Safety I/O** This section describes dedicated safety input (Yellow terminal with red text) and configurable I/O (Yellow terminals with black text) when configured as safety I/O. Safety devices and equipment must be installed according to the safety instructions and the risk assessment in chapter Safety. All safety I/O are paired (redundant), so a single fault does not cause loss of the safety function. However, the safety I/O must be kept as two separate branches.

The permanent safety input types are:

- **Robot Emergency Stop** for emergency stop equipment only
- **Safeguard Stop** for protective devices

**Table** The functional difference is shown below.

	Emergency Stop	Safeguard Stop	3PE Stop
Robot stops moving	Yes	Yes	Yes
Program execution	Pauses	Pauses	Pauses
Drive power	Off	On	On
Reset	Manual	Automatic or manual	Automatic or manual
Frequency of use	Infrequent	Every cycle to infrequent	Every cycle to infrequent
Requires re-initialization	Brake release only	No	No
Stop Category (IEC 60204-1)	1	2	2
Performance level of monitoring function (ISO 13849-1)	PLd	PLd	PLd

**Safety caution** Use the configurable I/O to set up additional safety I/O functionality, e.g. Emergency Stop Output. Use the PolyScope interface to define a set of configurable I/O for safety functions.



**CAUTION**

Failure to verify and test the safety functions regularly can lead to hazardous situations.

- Safety functions shall be verified before putting the robot into operation.
- Safety functions shall be tested regularly.

**OSSD signals**

All configured and permanent safety inputs are filtered to allow the use of OSSD safety equipment with pulse lengths under 3ms. The safety input is sampled every millisecond and the state of the input is determined by the most frequently seen input signal over the last 7 milliseconds.

**OSSD Safety Signals**

You can configure the Control Box to output OSSD pulses when a safety output is inactive/high. OSSD pulses detect the ability of the Control Box to make safety outputs active/low. When OSSD pulses are enabled for an output, a 1ms low pulse is generated on the safety output once every 32ms. The safety system detects when an output is connected to a supply and shuts down the robot. The illustration below shows: the time between pulses on a channel (32ms), the pulse length (1ms) and the time from a pulse on one channel to a pulse on the other channel (18ms)

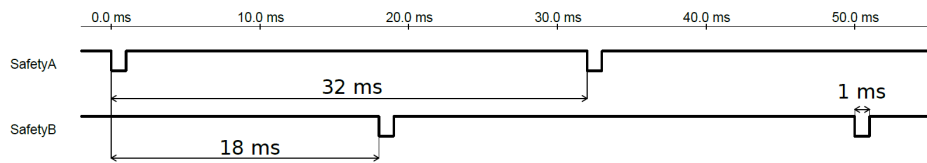

To enable OSSD for Safety Output

1. In the Header, tap **Installation** and select **Safety**.
2. Under **Safety**, select **I/O**.
3. On the I/O screen, under Output Signal, select the desired OSSD checkbox. You must assign the output signal to enable the OSSD checkboxes.

**Default safety configuration**

The robot is delivered with a default configuration, which enables operation without any additional safety equipment.

		Safety
Emergency Stop	24V	<input checked="" type="checkbox"/>
	E10	<input checked="" type="checkbox"/>
Safeguard Stop	24V	<input checked="" type="checkbox"/>
	E11	<input checked="" type="checkbox"/>
	S10	<input checked="" type="checkbox"/>
	24V	<input checked="" type="checkbox"/>
	S11	<input checked="" type="checkbox"/>

**Connecting emergency stop buttons**

Most applications require one or more extra emergency stop buttons. The illustration below shows how one or more emergency stop buttons can be connected.

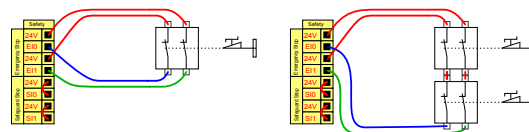

**Sharing the Emergency Stop with other machines**

You can set up a shared emergency stop function between the robot and other machines by configuring the following I/O functions via the GUI. The Robot Emergency Stop Input cannot be used for sharing purposes. If more than two UR robots or other machines need to be connected, a safety PLC must be used to control the emergency stop signals.

- Configurable input pair: External Emergency Stop.
- Configurable output pair: System Stop.

The illustration below shows how two UR robots share their emergency stop functions. In this example the configured I/Os used are CI0-CI1 and CO0-CO1.

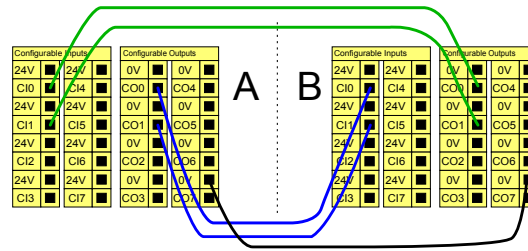

**Safeguard stop with automatic resume**

This configuration is only intended for applications where the operator cannot go through the door and close it behind him. The configurable I/O is used to setup a reset button outside the door to reactivate robot motion. The robot resumes movement automatically when the signal is re-established.



**WARNING**

Do not use this configuration if signal can be re-established from the inside of the safety perimeter.

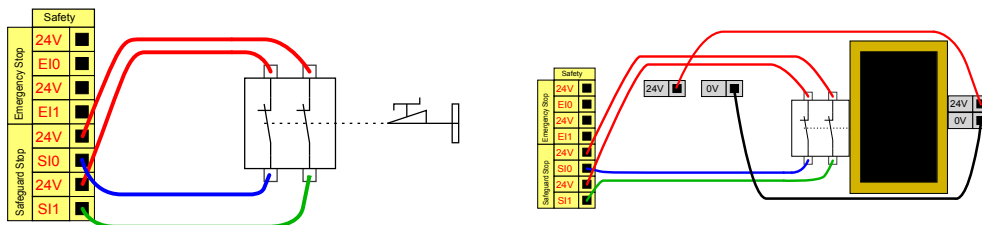

In this example a door switch is a basic safeguard device where the robot is stopped when the door is opened.

In this example a safety mat is a safety device where automatic resume is appropriate. This example is also valid for a safety laser scanner.

**Safeguard  
Stop with  
reset button**

If the safeguard interface is used to interact with a light curtain, a reset outside the safety perimeter is required. The reset button must be a two channel type. In this example the I/O configured for reset is CI0-CI1.

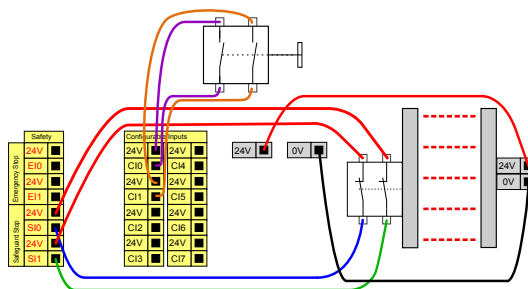

8.6.1. Safety I/O Signals

**Description**

The I/O are divided between inputs and outputs and are paired up so that each function provides a Category 3 PLd capability.

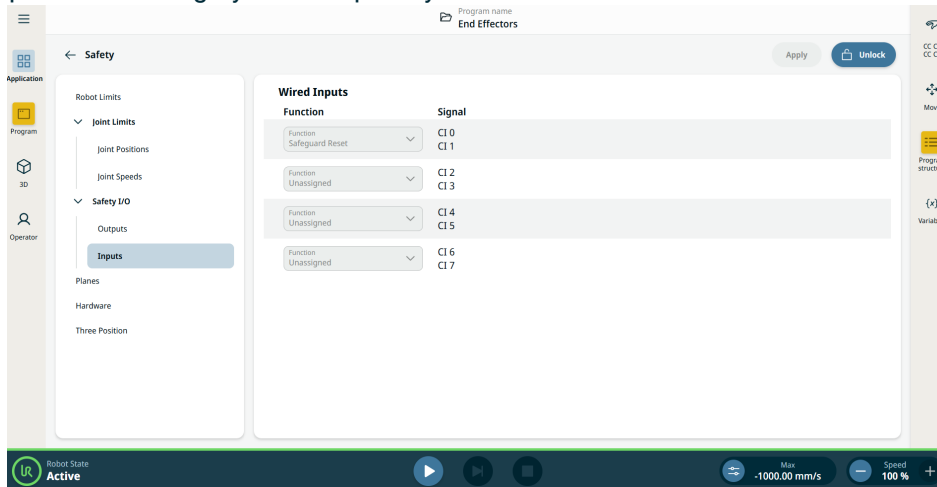
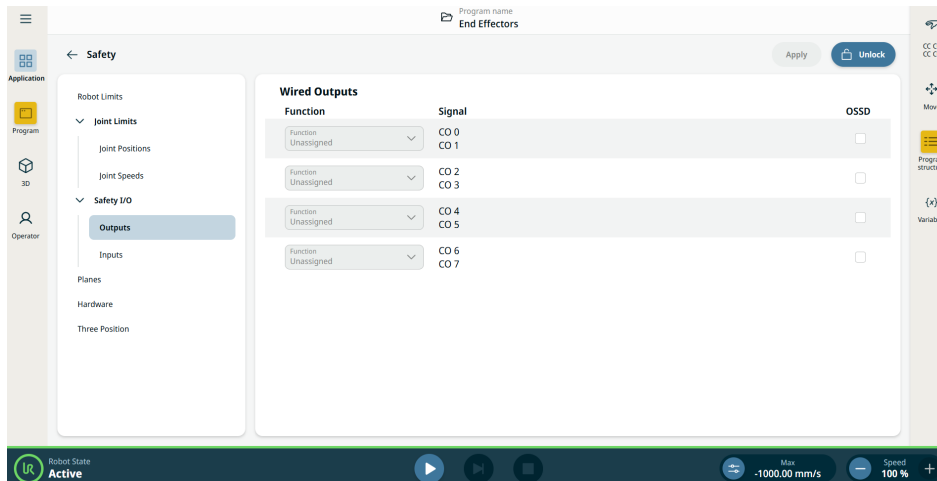

Figure 1.4: PolyScope X screen displaying the Input signals.



**NOTICE**

When starting programs from an I/O or fieldbus input, the robot can begin movement from the position it has, there will not be any manual movement to the first waypoint via PolyScope required.

Copyright © 2009-2026 by Universal Robots A/S. All rights reserved.

**Control Box Inputs** The inputs are described in the tables below:

Emergency Stop Button	Performs a Stop Category 1 (IEC 60204-1) informing other machines using the System Stop output if that output is defined. A stop is initiated in anything connected to the output.
Robot Emergency Stop	Performs a Stop Category 1 (IEC 60204-1) via Control Box input, informing other machines using the System Emergency Stop Output if that output is defined.
External Emergency Stop	Performs a Stop Category 1 (IEC 60204-1) on robot only.
Reduced	<p>All safety limits can be applied while the robot is using a <b>Normal</b> configuration, or a <b>Reduced</b> configuration.</p> <p>When configured, a low signal sent to the inputs causes the safety system to transition to the reduced configuration. The robot arm decelerates to satisfy the reduced parameters.</p> <p>The safety system guarantees the robot is within reduced limits less than 0.5s after the input is triggered. If the robot arm continues to violate any of the reduced limits, a Stop Category 0 is triggered. Trigger planes can also cause a transition to the reduced configuration. The safety system transitions to the normal configuration in the same way.</p>

The inputs are described in the table below:

**Control Box Inputs**

Operational Mode	When an external mode selection is used it switches between <b>Automatic Mode</b> and <b>Manual Mode</b> . The robot is in Automatic mode when input is <i>low</i> and Manual mode when the input is <i>high</i> .
Safeguard Reset	Returns from the Safeguard Stop state, when a rising edge on the Safeguard Reset input occurs. When a Safeguard Stop occurs, this input ensures that the Safeguard Stop state continues until a reset is triggered.
Safeguard	A stop triggered by a safeguard input. Performs a Stop Category 2 (IEC 60204-1) in all modes, when triggered by a Safeguard.
Automatic Mode Safeguard Stop	Performs a Stop Category 2 (IEC 60204-1) in Automatic mode ONLY. <i>Automatic Mode Safeguard Stop</i> can only be selected when a Three-Position Enabling Device is configured and installed.
Automatic Mode Safeguard Reset	Returns from the Automatic Mode Safeguard Stop state when a rising edge on the Automatic Mode Safeguard Reset input occurs.
Freedrive on robot	You can configure the Freedrive input to enable and use Freedrive without pressing the Freedrive button on a standard TP, or without having to press-and-hold any of the buttons on the 3PE TP in the light-press position.
3-Position Enabling Device	In Manual Mode, an external 3-Position Enabling Device must be pressed and held in the center-on position to move the robot. If you are using a built-in 3-Position Enabling Device, the button must be pressed and held in the mid position to move the robot.



**WARNING**

When the default Safeguard Reset is disabled, an automatic reset happens when the safeguard no longer triggers a stop.

This can happen if a person passes through the field of the safeguard.

If a person is not detected by the safeguard and the person is exposed to hazards, automatic reset is forbidden by standards.

- Use the external reset to ensure resetting only when a person is not exposed to hazards.



**WARNING**

When Automatic Mode Safeguard stop is enabled, a safeguard Stop is not triggered in Manual Mode.

**Contr** All safety outputs go low in the event of a safety system violation or fault. This means the System  
**ol Box** Stop output initiates a stop even when an E-stop is not triggered.  
**Output** You can use the following Safety functions output signals. All signals return to low when the state  
**ts** which triggered the high signal has ended:

<sup>1</sup> System Stop	Signal is <i>Low</i> when the safety system has been triggered into a stopped state including by the Robot Emergency Stop input or the Emergency Stop Button. To avoid deadlocks, if the Emergency Stopped state is triggered by the System Stop input, low signal will not be given.
Robot Moving	Signal is <i>Low</i> if the robot is moving, otherwise high.
Robot Not Stopping	Signal is <i>High</i> when the robot is stopped or in the process of stopping due to an emergency stop or safeguard stop. Otherwise it will be logic low.
Reduced	Signal is <i>Low</i> when reduced parameters are active or if the safety input is configured with a reduced input and the signal is currently low. Otherwise the signal is high.
Not Reduced	This is the inverse of Reduced, defined above.
Safe Home	Signal is <i>High</i> if the robot arm is stopped and is located in the configured Safe Home Position. Otherwise, the signal is <i>Low</i> . This is often used when UR robots are integrated with mobile robots.
3-Position Enabling Stopped	Signal is low when a three position stop is active, high otherwise.
Not 3-Position Enabling Stopped	Signal is low when a three position stop is inactive, high otherwise.



#### NOTICE

Any external machinery receiving its Emergency Stop state from the robot through the System Stop output must comply with ISO 13850. This is particularly necessary in setups where the Robot Emergency Stop input is connected to an external Emergency Stop device. In such cases, the System Stop output becomes high when the external Emergency Stop device is released. This implies that the emergency stop state at the external machinery will be reset with no manual action needed from the robot's operator. Hence, to comply with safety standards, the external machinery must require manual action in order to resume.

<sup>1</sup>System Stop was previously known as "System Emergency Stop" for Universal Robots robots. PolyScope can display "System Emergency Stop".

## 8.6.2. I/O Setup

### Description

Use the I/O Setup screen to define I/O signals and configure actions with the I/O tab control. The types of I/O signals are listed under **Input** and **Output**.

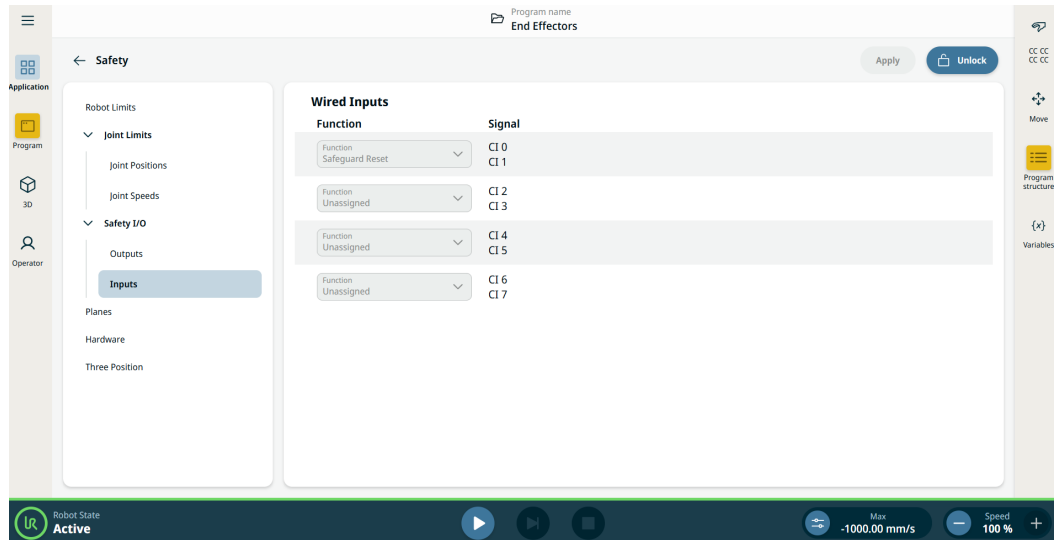

### NOTICE

When starting programs from an I/O or fieldbus input, the robot can begin movement from the position it has, there will not be any manual movement to the first waypoint via PolyScope required.

### Inputs

1. To the Application .
2. Go to Safety.
3. Tap the **Inputs** in the **Safety I/O** section.
4. Unlock the settings.
5. Assign a function to the signal group.

See the Safety I/O Signals for a description of the safety function.

**Available  
Input Actions**

Command	Action
Start	Starts or resumes the current program on a rising edge (only enabled in Remote Control)
Stop	Stops the current program on a rising edge
Pause	Pauses the current program on a rising edge
Freedrive	When the input is high, the robot goes into Freedrive (similar to the <b>Freedrive</b> button). The input is ignored if other conditions disallow Freedrive.

**WARNING**

If the robot is stopped while using the Start input action, the robot slowly moves to the first waypoint of the program before executing that program. If the robot is paused while using the Start input action, the robot slowly moves to the position from where it was paused before resuming that program.

**Outputs**

1. To the Application .
2. Go to Safety.
3. Tab the Outputs in the Safety I/O section.
4. Unlock the settings.
5. Assign a function to the signal group.

You can enable OSSD on each output signal.  
See the Safety I/O Signals for a description of the safety function.

**Available  
Output  
Actions**

Action	Output state	Program state
Low when not running	Low	Stopped or paused
High when not running	High	Stopped or paused
High when running, low when stopped	Low High	Running, Stopped or paused
Low on unscheduled stop	Low	Program terminated unscheduled
Low on unscheduled stop, otherwise High	Low High	Program terminated unscheduled Running, stopped or paused
Continuous Pulse	Alternates between high and low	Running (pause or stop the program to maintain the pulse state)



**Program  
Termination  
Cause**

An unscheduled program termination can occur for any of the reasons listed below:

- Robot stop
  - Fault
  - Violation
  - Runtime exception
-

### 8.6.3. Using I/O for Mode Selection

**Description** The robot can be configured to switch between operational modes without using the Teach Pendant. This means using the TP is prohibited when switching from Automatic mode to Manual mode and from Manual mode to Automatic mode.

Switching modes without the use of the Teach Pendant requires safety I/O configuration and a secondary device as a mode selector.

**Mode selector** The mode selector can be a key switch with a redundant electrical layout or with signals from a dedicated safety PLC.

**To use the mode selector** Using the mode selector, such as a key switch, prevents the TP from being used to switch between the modes.

1. Connect your mode selector to the inputs as shown in the image below.
2. Verify the mode selector is correctly connected and configured.

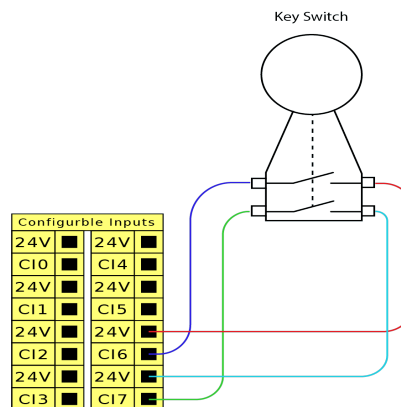

**To configure the connected safety inputs**

Configuring the safety inputs for the secondary device connection requires unlocking the safety I/O screen.

1. In the main navigation, tap **Application**.

2. Select **Safety** and tap **Unlock**.

When prompted, input your password to unlock the Safety screen.

If you have not previously defined a password, use the default password: `ursafe`.

3. Under Safety I/O select **Inputs**.

4. Select one of the input signals by tapping one of the Input dropdown options.

5. In the dropdown list, select **Operational Mode**.

6. Tap **Apply** and allow the robot restart.

7. Tap **Confirm Safety Configuration**.

You can now only use the secondary device to select and/or switch between operational modes.

Once the input is assigned to the secondary device, switching modes via the TP is disabled. If an attempt is made to use the TP to switch modes, a message appears confirming the TP cannot be used to change the operational mode.

### 8.6.4. Three Position Enabling Device

**Description**

The robot is equipped with an enabling device in the form of the 3PE Teach Pendant. The Control Box supports the following enabling device configurations:

- 3PE Teach Pendant
- External Three-Position Enabling device
- External Three-Position device and 3PE Teach Pendant

The illustration below shows how to connect a Three-Position Enabling device.

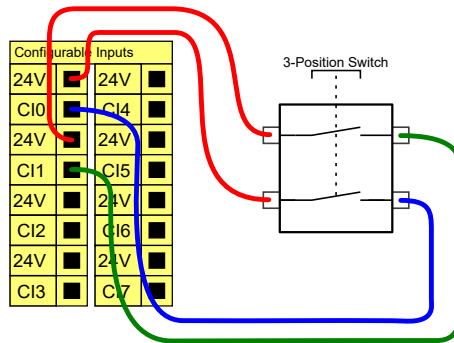

Note: The two input channels for the Three-Position Enabling Device input have a disagreement tolerance of 1 second.

**NOTICE**

The UR robot safety system does not support multiple external Three-Position Enabling Devices.

**Operational Mode Switch**

Using a Three-Position Enabling device requires the use of an Operational Mode switch.

The illustration below shows an Operational Mode switch.

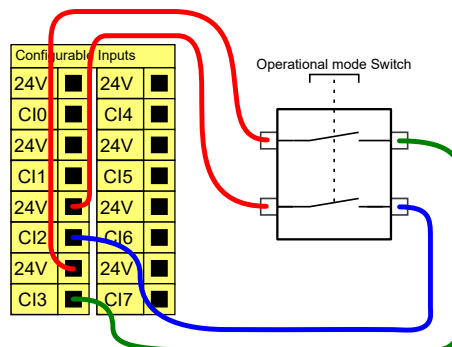

## 8.7. General Purpose Digital I/O

**Description** The Startup screen contains settings for automatically loading and starting a default program, and for auto-initializing the Robot arm during power up.

**General purpose digital I/O** This section describes the general purpose 24V I/O (Gray terminals) and the configurable I/O (Yellow terminals with black text) when not configured as safety I/O.

The general purpose I/O can be used to drive equipment like pneumatic relays directly or for communication with other PLC systems. All Digital Outputs can be disabled automatically when program execution is stopped. In this mode, the output is always low when a program is not running. Examples are shown in the following subsections. These examples use regular Digital Outputs but any configurable outputs could also have been used if they are not configured to perform a safety function.

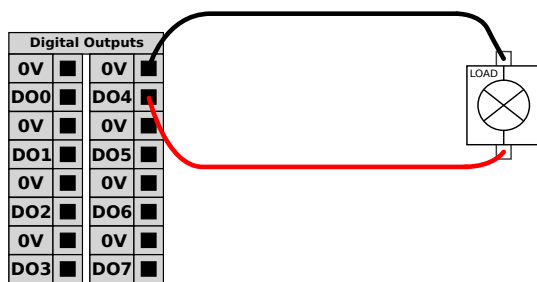

In this example a load is controlled from a Digital Outputs when connected.

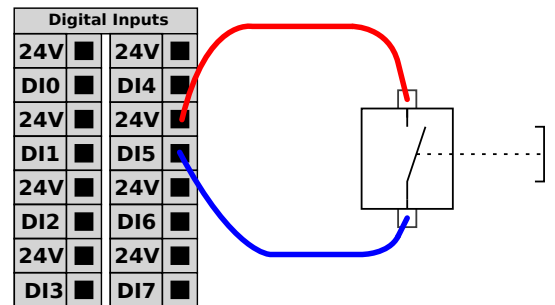

In this example a simple button is connected to a Digital Input.

**Communication with other machines or PLCs** You can use the digital I/O to communicate with other equipment if a common GND (0V) is established and if the machine uses PNP technology, see below.

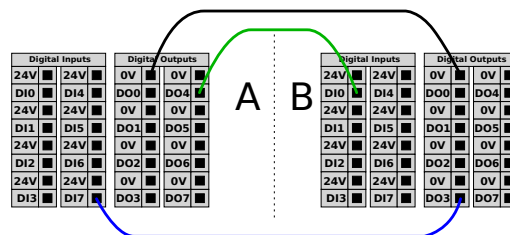

**NOTICE**

Use shielded cables to connect Digital I/Os.

### 8.7.1. Remote ON/OFF control

**Description** Use remote **ON/OFF** control to turn the Control Box on and off without using the Teach Pendant. It is typically used:

- When the Teach Pendant is inaccessible.
- When a PLC system must have full control.
- When several robots must be turned on or off at the same time.

**Remote Control** The remote **ON/OFF** control provides a auxiliary 12V supply, kept active when the Control Box is turned off. The **ON** input is intended only for short time activation and works in the same way as the **POWER** button. The **OFF** input can be held down as desired. Use a software feature to load and start programs automatically.

The electrical specifications are shown below.

Terminals	Parameter	Min	Typ	Max	Unit
[12V - GND]	Voltage	10	12	13	V
[12V - GND]	Current	-	-	100	mA
[ON / OFF]	Inactive voltage	0	-	0.5	V
[ON / OFF]	Active voltage	5	-	12	V
[ON / OFF]	Input current	-	1	-	mA
[ON]	Activation time	200	-	600	ms

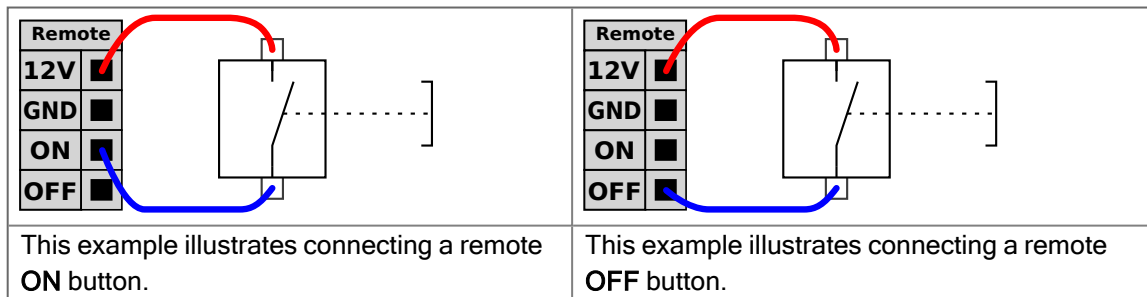

**CAUTION**

Maintaining a press and hold on the power button switches the Control Box OFF without saving.

- Do not press and hold the **ON** input or the **POWER** button without saving.
- Use the **OFF** input for remote off control to allow the Control Box to save open files and shut down correctly.

## 8.8. General Purpose Analog I/O

### Description

The analog I/O interface is the green terminal. It is used to set or measure voltage (0-10V) or current (4-20mA) to and from other equipment.

The following directions is recommended to achieve the highest accuracy.

- Use the AG terminal closest to the I/O. The pair share a common mode filter.
- Use the same GND (0V) for equipment and Control Box. The analog I/O is not galvanically isolated from the Control Box.
- Use a shielded cable. Connect the shield to the GND terminal at the terminal called **Power**.
- Use equipment that works in current mode. Current signals are less sensitive to interferences.

### Electrical Specifications

In the GUI you can select input modes. The electrical specifications are shown below.

Terminals	Parameter	Min	Typ	Max	Unit
<i>Analog Input in current mode</i>					
[AIx - AG]	Current	4	-	20	mA
[AIx - AG]	Resistance	-	20	-	ohm
[AIx - AG]	Resolution	-	12	-	bit
<i>Analog Input in voltage mode</i>					
[AIx - AG]	Voltage	0	-	10	V
[AIx - AG]	Resistance	-	10	-	Kohm
[AIx - AG]	Resolution	-	12	-	bit
<i>Analog Output in current mode</i>					
[AOx - AG]	Current	4	-	20	mA
[AOx - AG]	Voltage	0	-	24	V
[AOx - AG]	Resolution	-	12	-	bit
<i>Analog Output in voltage mode</i>					
[AOx - AG]	Voltage	0	-	10	V
[AOx - AG]	Current	-20	-	20	mA
[AOx - AG]	Resistance	-	1	-	ohm
[AOx - AG]	Resolution	-	12	-	bit

### Analog Output and Analog Input

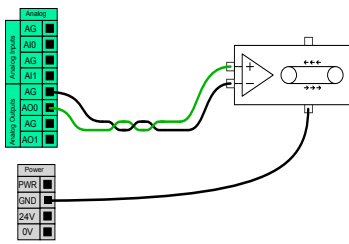

This example illustrates controlling a conveyor belt with an analog speed control input.

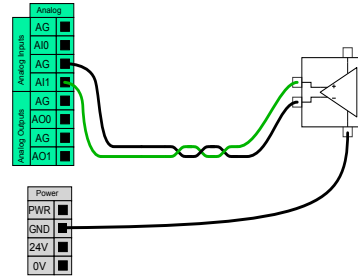

This example illustrates connecting an analog sensor.

## 8.9. Remote Mode in Safety Overview

**Description** When activated, Remote Mode allows external devices to connect to key services such as the Primary Interface.

Remote Mode can be toggled via a dedicated switch in the Safety Overview dialog.

1. Go to the safety overview in the main screen.
2. Click Mode Selection.
3. You can now select Automatic and then Remote.

"Local" is toggled as a default.

"Remote" is only active when the application is in Automatic mode.

### Toggle Access

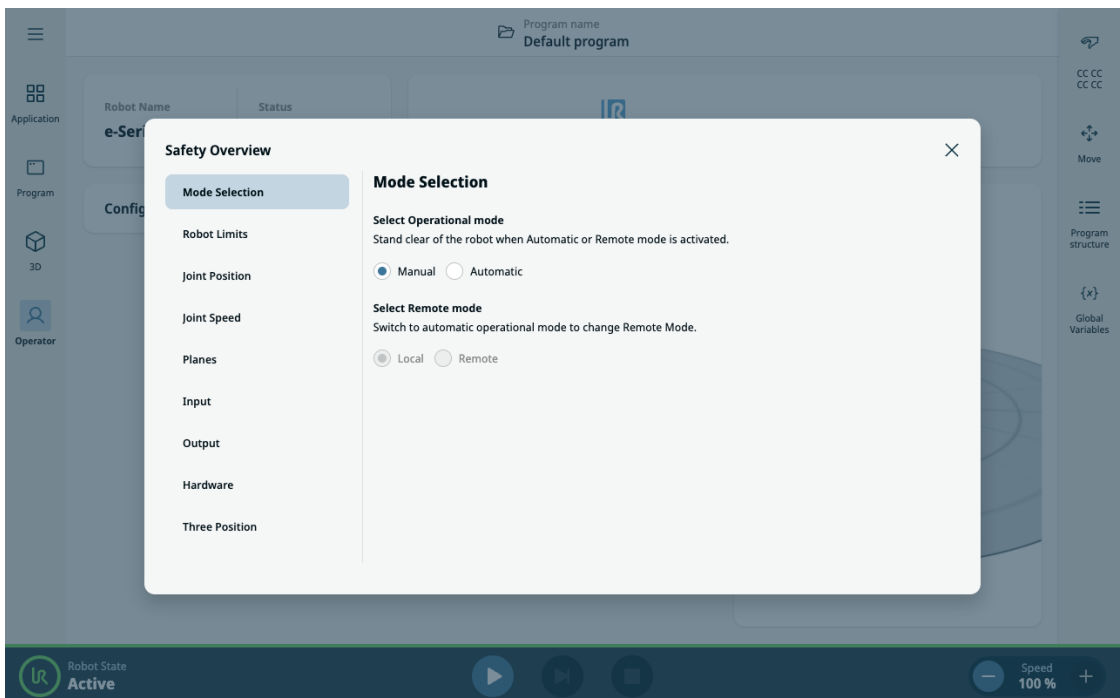

Copyright © 2009-2026 by Universal Robots A/S. All rights reserved.

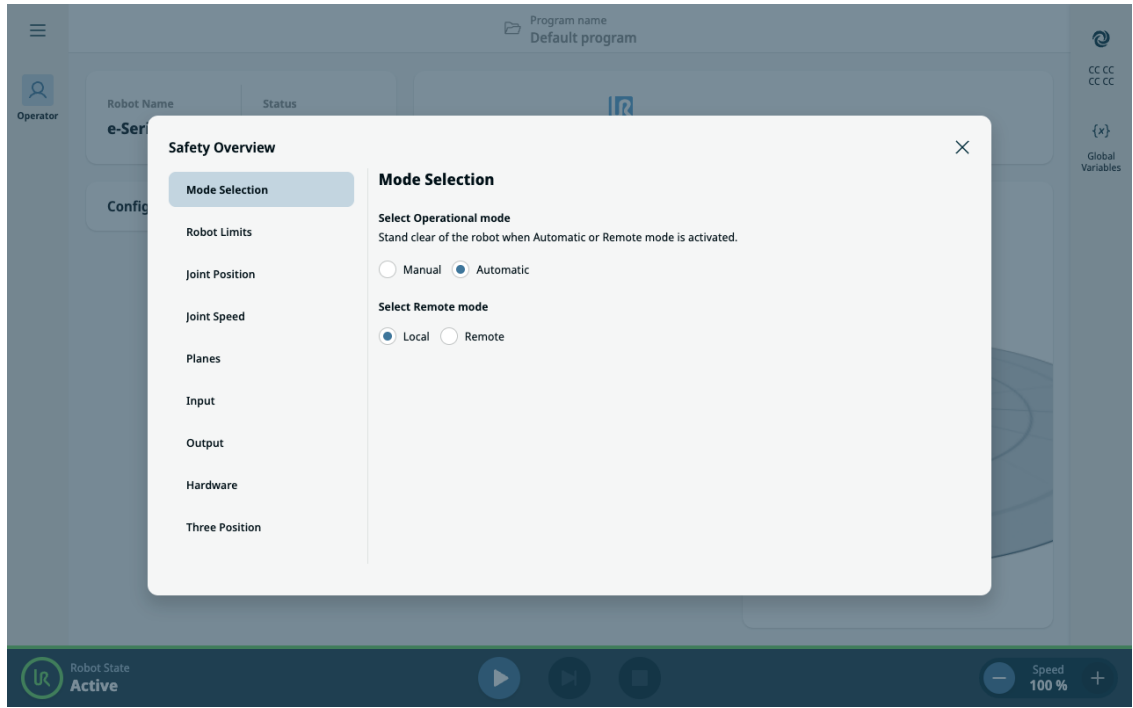

Copyright © 2009-2026 by Universal Robots A/S. All rights reserved.

**Secure Lockdown**

While in Remote Mode, the PolyScope X interface enters a secure, read-only state. All editing and control actions are disabled, and only the Operator Screen remains accessible in view-only mode. Additionally, a Remote Mode icon is displayed above the Safety checksum to clearly indicate the system is under remote supervision.

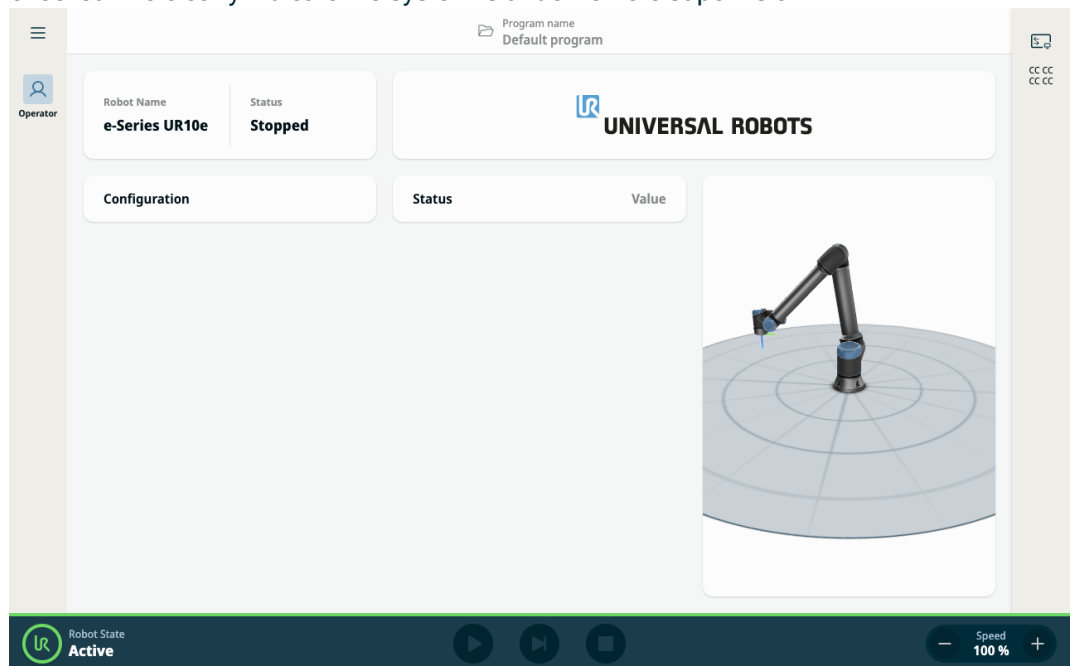

**I/O Controlled Safety**

If the robot's operational mode is governed by an I/O signal, switching to Manual mode via I/O will automatically revert Remote Mode back to Local Mode. This feature ensures a safe and structured environment for remote monitoring, while preserving local control integrity when needed.

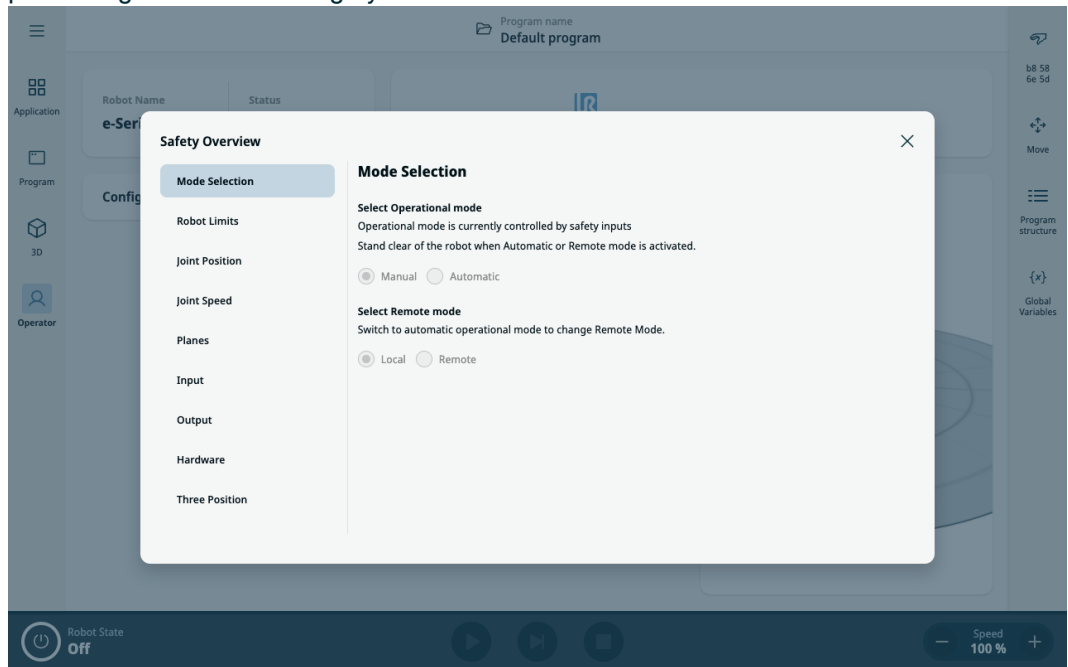

Copyright © 2009-2026 by Universal Robots A/S. All rights reserved.

# 9. End Effector Integration

---

**Description** The end effector can also be referred to as the tool and the workpiece in this manual.



**NOTICE**

UR provides documentation for the end effector to be integrated with the robot arm.

- Refer to the documentation specific to the end effector/tool/workpiece for mounting and connection.

## 9.1. Maximum Payload

---

**Description** The rated robot arm payload depends on the center of gravity (CoG) offset of the payload, as shown below. The CoG offset is defined as the distance from the center of the tool flange to the center of gravity of the attached payload.

The robot arm can accommodate a long center of gravity offset, if the payload is placed below the tool flange. For example when computing the payload mass in a pick and place application, consider both the gripper and the workpiece.

The robot's capacity to accelerate can be reduced if the payload CoG exceeds the robot's reach and payload. You can verify the reach and payload of your robot in the Technical Specifications.

Payload [kg]

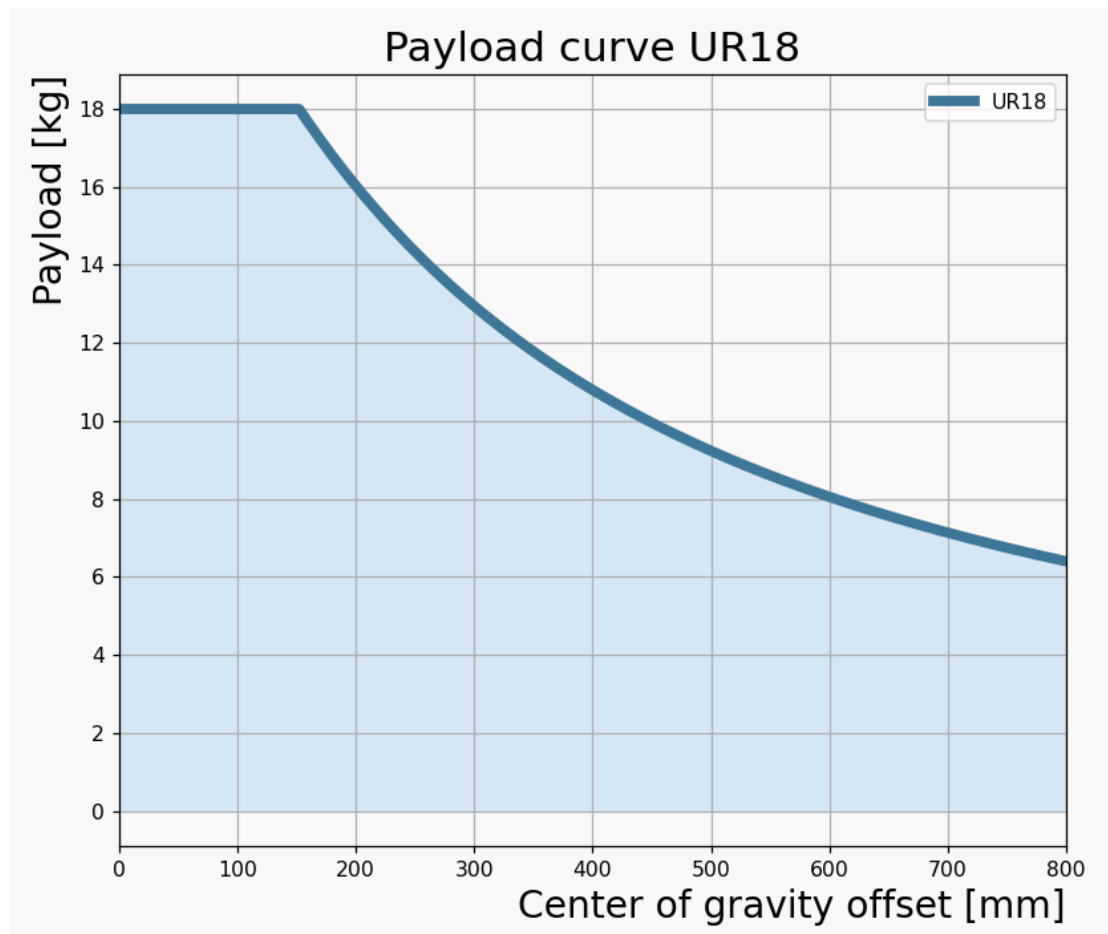

Center of gravity offset [mm]

*The relationship between the rated payload and the center of gravity offset.*

### Payload inertia

You can configure high inertia payloads, if the payload is set correctly. The controller software automatically adjusts accelerations when the following parameters are correctly configured:

- Payload mass
- Center of gravity
- Inertia

You can use the URSim to evaluate the accelerations and cycle times of the robot motions with a specific payload.

## 9.2. Securing Tool

**Description** The tool or workpiece is mounted to the tool output flange (ISO) at the tip of the robot.

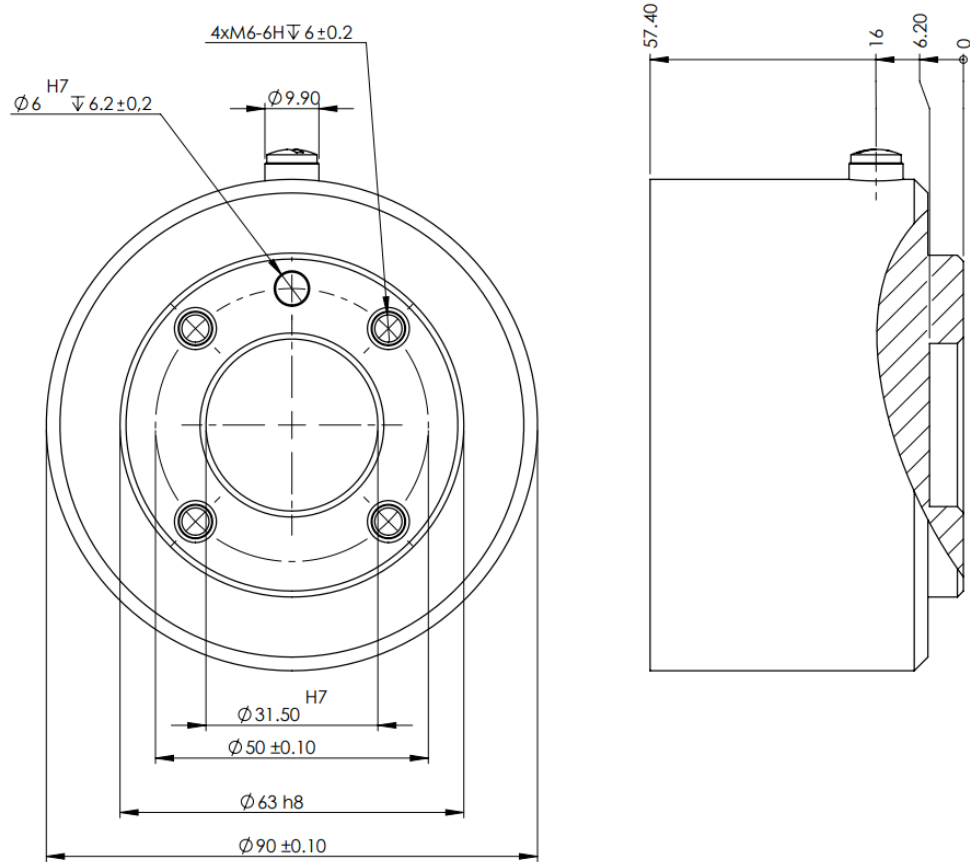

Dimensions and hole pattern of the tool flange. All measurements are in millimeters.

**Tool flange** The tool output flange (ISO 9409-1) is where the tool is mounted at the tip of the robot. It is recommended to use a radially slotted hole for the positioning pin to avoid over-constraining, while keeping precise position.



**CAUTION**

Very long M6 bolts can press against the bottom of the tool flange and short circuit the robot.

- Do not use bolts that extend beyond 8 mm to mount the tool.



**WARNING**

Failure to tighten bolts properly cause injury due to loss of the adapter flange and/or end effector.

- Ensure the tool is properly and securely bolted in place.
- Ensure the tool is constructed such that it cannot create a hazardous situation by dropping a part unexpectedly.



## 9.3. Tool I/O

### Tool Connector

The tool connector illustrated below provides power and control signals for the grippers and sensors used on a specific robot tool. The tool connector has eight holes and is located next to the tool flange on Wrist 3.

The eight wires inside the connector have different functions, as listed below:

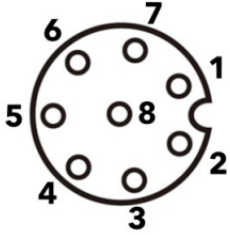
	Pin #	Signal	Description
	1	AI0 / RS485-	Analog in 0 or RS485-
	2	AI1 / RS485+	Analog in 1 or RS485+
	3	TO0/PWR	Digital Outputs 0 or 0V/12V/24V
	4	TO1/GND	Digital Outputs 1 or Ground
	5	POWER	0V/12V/24V
	6	TI0	Digital Inputs 0
	7	TI1	Digital Inputs 1
	8	GND	Ground



#### NOTICE

The Tool Connector must be manually tightened up to a maximum of 0.4 Nm.

### Tool I/O Accessories

The tool I/O for all Universal Robots robots can require an accessory element to facilitate connection with tools. You can use the Tool Cable Adapter.

**Tool Cable Adapter** The Tool Cable Adapter is the electronic accessory that allows compatibility between tool I/O and tools.

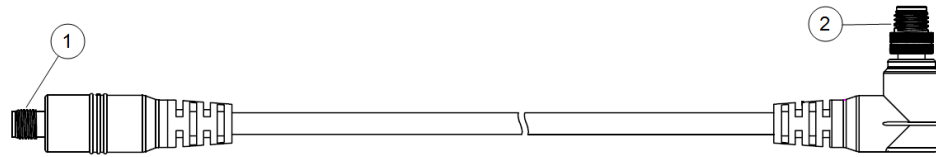

1	Connects to the tool/end effector.
2	Connects to the robot.



**WARNING**

Connecting the Tool Cable Adapter to a robot that is powered on can lead to injury.

- Connect the adapter to the tool/end effector before connecting the adapter to the robot.
- Do not power on the robot if the Tool Cable Adapter is not connected to the tool/end effector.

The eight wires inside the Tool Cable Adapter have different functions, as listed below:

	Pin #	Signal	Description
	1	AI0 / RS485+	Analog in 0 or RS485+
	2	AI1 / RS485-	Analog in 1 or RS485-
	3	TI1	Digital Inputs 1
	4	TI0	Digital Inputs 0
	5	POWER	0V/12V/24V
	6	TO1/GND	Digital Outputs 1 or Ground
	7	TO0/PWR	Digital Outputs 0 or 0V/12V/24V
	8	GND	Ground



**GROUND**

The tool flange is connected to GND (Ground).

### 9.3.1. Tool I/O Installation Specifications

**Description** The electrical specifications are shown below. Access Tool I/O in the Installation Tab to set the internal power supply to 0V, 12V or 24V.

Parameter	Min	Typ	Max	Unit
Supply voltage in 24V mode	23.5	24	24.8	V
Supply voltage in 12V mode	11.5	12	12.5	V
Supply current (single pin)*	-	1000	2000**	mA
Supply current (dual pin)*	-	2000	2000**	mA
Supply capacitive load	-	-	8000***	uF

\* It is highly recommended to use a protective diode for inductive loads.

\*\* Peak for max 1 second, duty cycle max: 10%. Average current over 10 seconds must not exceed typical current.

\*\*\* When tool power is enabled, a 400 ms soft start time begins allowing a capacitive load of 8000 uF to be connected to the tool power supply at start-up. Hot-plugging the capacitive load is not allowed.

## 9.3.2. Tool Power Supply

**Description** Access Tool I/O in the Installation Tab

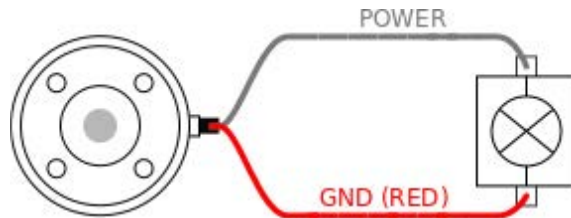

### Dual Pin Power Supply

In Dual Pin Power mode, the output current can be increased as listed in Tool I/O.

1. In the Header, tap **Installation**.
2. In the list on the left, tap **General**.
3. Tap **Tool IO** and select **Dual Pin Power**.
4. Connect the wires Power (gray) to TO0 (blue) and Ground (red) to TO1 (pink).

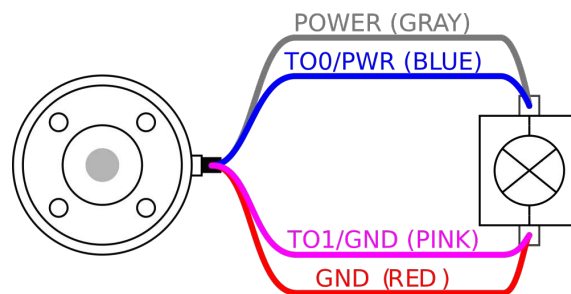

#### NOTICE

Once the robot makes an Emergency Stop, the voltage is set to 0V for both Power Pins (power is off).

## 9.3.3. Tool Digital Inputs

**Description** The Startup screen contains settings for automatically loading and starting a default program, and for auto-initializing the Robot arm during power up.

**Table** The Digital Inputs are implemented as PNP with weak pull-down resistors. This means that a floating input always reads as low. The electrical specifications are shown below.

Parameter	Min	Type	Max	Unit
Input voltage	-0.5	-	26	V
Logical low voltage	-	-	2.0	V
Logical high voltage	5.5	-	-	V
Input resistance	-	47k	-	$\Omega$

**Using the Tool Digital Inputs**

This example illustrates connecting a simple button.

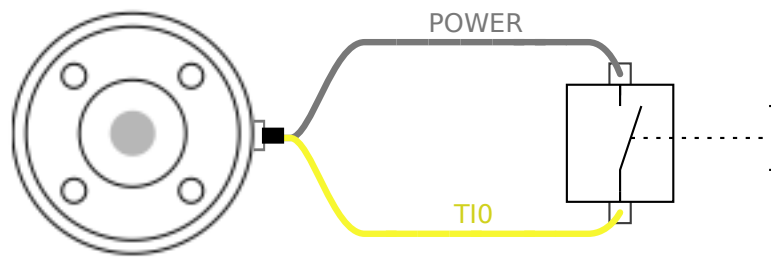

### 9.3.4. Tool Digital Outputs

**Description** Digital Outputs support three different modes:

Mode	Active	Inactive
Sinking (NPN)	Low	Open
Sourcing (PNP)	High	Open
Push / Pull	High	Low

Access Tool I/O in the Installation Tab to configure the output mode of each pin. The electrical specifications are shown below:

Parameter	Min	Typ	Max	Unit
Voltage when open	-0.5	-	26	V
Voltage when sinking 1A	-	0.08	0.09	V
Current when sourcing/sinking	0	600	1000	mA
Current through GND	0	1000	3000*	mA



**NOTICE**

Once the robot makes an Emergency Stop, the Digital Outputs (DO0 and DO1) are deactivated (High Z).



**CAUTION**

The Digital Outputs in the tool are not current-limited. Overriding the specified data can cause permanent damage.

**Using Tool Digital Outputs**

This example illustrates turning on a load using the internal 12V or 24V power supply. The output voltage at the I/O tab must be define. There is voltage between the POWER connection and the shield/ground, even when the load is turned off.

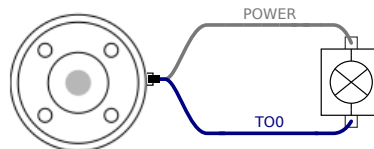

It is recommended to use a protective diode for inductive loads, as shown below.

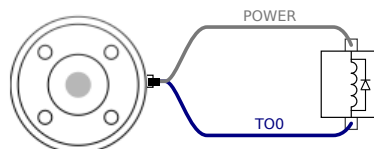

Copyright © 2009-2026 by Universal Robots A/S. All rights reserved.

### 9.3.5. Tool Analogue Inputs

**Description** Tool Analogue Input are non-differential and can be set to either voltage (0-10V) or current (4-20mA) on the I/O tab. The electrical specifications are shown below.

Parameter	Min	Type	Max	Unit
Input voltage in voltage mode	-0.5	-	26	V
Input resistance @ range 0V to 10V	-	10.7	-	kΩ
Resolution	-	12	-	bit
Input voltage in current mode	-0.5	-	5.0	V
Input current in current mode	-2.5	-	25	mA
Input resistance @ range 4mA to 20mA	-	182	188	Ω
Resolution	-	12	-	bit

Two examples of using Analog Input are shown in the following subsections.

**Caution**



**CAUTION**

Analog Inputs are not protected against over voltage in current mode. Exceeding the limit in the electrical specification can cause permanent damage to the input.

**Using Tool Analog Inputs, Non-differential**

This example shows an analog sensor connection with a non-differential output. The sensor output can be either current or voltage, as long as the input mode of that Analog Input is set to the same on the I/O tab.

Note: You can check that a sensor with voltage output can drive the internal resistance of the tool, or the measurement might be invalid.

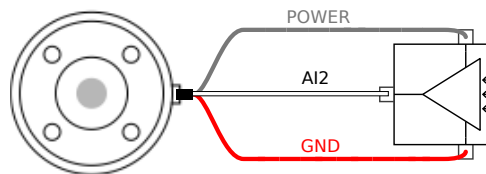

**Using Tool Analog Inputs, differential**

This example shows an analog sensor connection with a differential output. Connecting the negative output part to GND (0V), works in the same way as a non-differential sensor.

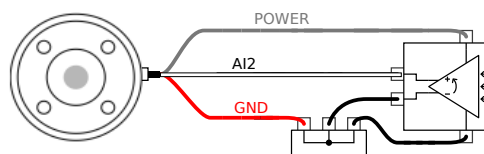

## 9.4. Set Payload

### 9.4.1. Safely Setting the Active Payload

#### Verify installation

Before using PolyScope X, verify that the Robot Arm and Control Box are correctly installed.

1. On the Teach Pendant, press the emergency stop button.
2. On the screen, tap **OK** when the Robot Emergency Stop box appears.
3. On the Teach Pendant, press the power button and allow the system to start and load PolyScope X.
4. Tap the on-screen **Power** button at the bottom left of the screen.
5. Hold and twist the emergency stop button to unlock.
6. On the screen's footer, verify the **Robot State is Off**.
7. Step outside the reach (workspace) of the robot arm.
8. Tap the on-screen **Power** button.
9. In the Initialize box, tap **Power On**, and the robot state is changed to **Locked**.
10. In the Active Payload, verify the payload mass.  
You can also verify the mounting position is correct, in the 3D view.
11. Tap the **Active Payload** field, and an **Edit** field appears in the main screen.
12. Enter your active payload and **Confirm**.

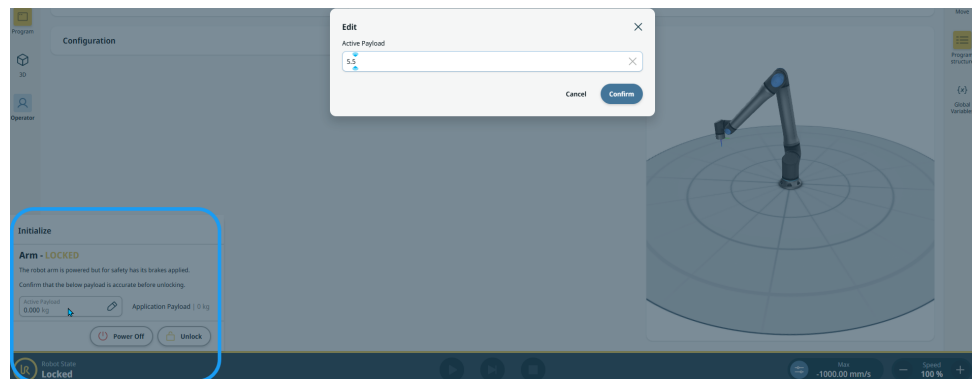

13. Tap **Unlock** for the robot arm to release its brake system.

# 10. Safety Configuration

**Description** This section describes the safety configuration that is possible in the application tab.

## 10.1. Safety Related Functions and Interfaces

**Description** Universal Robots robots are equipped with a range of built-in safety functions as well as safety I/O, digital and analog control signals to or from the electrical interface, to connect to other machines and additional protective devices. Each safety function and I/O is constructed according to EN ISO13849-1 with Performance Level d (PLd) using a category 3 architecture.



### WARNING

The use of safety configuration parameters different from those determined as necessary for risk reduction, can result in hazards that are not reasonably eliminated, or risks that are not sufficiently reduced.

- Ensure tools and grippers are connected correctly to avoid hazards due to interruption of power.



### WARNING: ELECTRICITY

Programmer and/or wiring errors can cause the voltage to change from 12V to 24V leading to fire damage to equipment.

- Verify the use of 12V and proceed with caution.



### NOTICE

- The use and configuration of safety functions and interfaces must follow the risk assessment procedures for each robot application.
- The stopping time should be taken into account as part of the application risk assessment
- If the robot detects a fault or violation in the safety system (e.g. if one of the wires in the Emergency Stop circuit is cut or a safety limit is exceeded), then a Stop Category 0 is initiated.



### NOTICE

The end effector is not protected by the UR safety system. The functioning of the end effector and/or connection cable is not monitored

### 10.1.1. Configurable Safety Functions

**Description** Universal Robots robot safety functions, as listed in the table below, are in the robot but are meant to control the robot system i.e. the robot with its attached tool/end effector. The robot safety functions are used to reduce robot system risks determined by the risk assessment. Positions and speeds are relative to the base of the robot.

Safety Functions	Safety Function	Description
	Joint Position Limit	Sets upper and lower limits for the allowed joint positions.
	Joint Speed Limit	Sets an upper limit for joint speed.
	Safety Planes	Defines planes, in space, that limit robot position. Safety planes limit either the tool/end effector alone or both the tool/end effector and the elbow.
	Tool Orientation	Defines allowable orientation limits for the tool.
	Speed Limit	Limits maximum robot speed. The speed is limited at the elbow, at the tool/end effector flange, and at the center of the user-defined tool/end effector positions.
	Force Limit	Limits maximum force exerted by the robot tool/end effector and elbow in clamping situations. The force is limited at the tool/end effector, elbow flange and center of the user-defined tool/end effector positions.
	Momentum Limit	Limits maximum momentum of the robot.
	Power Limit	Limits mechanical work performed by the robot.
	Stopping Time Limit	Limits maximum time the robot uses for stopping after a protective stop is initiated.
	Stopping Distance Limit	Limits maximum distance travelled by the robot after a protective stop is initiated.

**Risk assessment** When performing the application risk assessment, it is necessary to take into account the motion of the robot after a stop has been initiated. In order to ease this process, the safety functions *Stopping Time Limit* and *Stopping Distance Limit* can be used. These safety functions dynamically reduces the speed of the robot motion such that it can always be stopped within the limits. The joint position limits, the safety planes and the tool/end effector orientation limits take the expected stopping distance travel into account i.e. the robot motion will slow down before the limit is reached.

Copyright © 2009-2026 by Universal Robots A/S. All rights reserved.

## 10.2. Settings

---

**Description** The settings in PolyScope X can be accessed via the hamburger menu in the main navigation.

You can access the following sections:

- General
  - Password
  - Connection
  - Security
- 

**General Settings** In the general settings, you can change the preferred language, units of measurements, etc. You also update the software from the general settings.

**Password Settings** In the password settings, you can find the default passwords, and how to change them to the preferred and secure passwords.

**Connection Settings** In the connection settings, you can set network settings such as IP address, DNS server, etc. Settings related to UR Connect is also found here.

**Security Settings** The security settings related to SSH, admin password permissions and enabling/disabling of various services in the software.

---

### 10.2.1. Password

---

**Description** In the password settings in PolyScope X, you can find three different types of password.

- Operational Mode
- Safety
- Admin

It is possible to set the same password in all three instances, but it is also possible to set three different password to separate access and options.

---

#### Password - Admin

---

**Description**

All options under Security are protected by an Admin password. The Admin password protected screens are locked by a transparent overlay rendering the settings unavailable. Accessing the Security allows you to configure the settings in the following:

- Secure Shell
- Permissions
- Services

The settings can only be modified by designated administrator/s. Unlocking any one of the options under Security, also unlocks the other options until you exit the Settings menu.

**Default Password**

The default password for the admin password is: easybot



**NOTICE**

If you forget your admin password, it cannot be replaced or recovered. You will have to reinstall the software.

**To set the Admin password**

Before you can use the Admin password to unlock protected screens, you have to change the default password.

1. Access the Hamburger menu and select **Settings**.
2. Under Password, tap **Admin**.
3. Change the current Admin password to a new one.
  - If this is the first time, change the default Admin password from "easybot" to a new password. The new password must be at least 8 characters long.
4. Use the new password to unlock the Settings menu and access the options under Security.

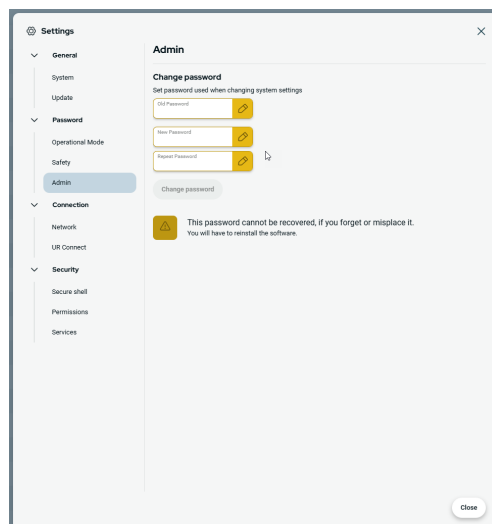

**To exit the Settings menu** When one of the Security options is unlocked, the Close button in the bottom right of the Settings menu changes. The Close button is replaced by the Lock and Close button indicating security is unlocked.

1. On the Settings menu locate and tap the **Lock and Close** button.

## Password - Operational Mode

### Default Password

The default password for operational mode: operator

i

**NOTICE**

If you forget your password, it cannot be replaced or recovered. You will have to reinstall the software.

You must use the default password, when you change the password for the first time.

### Change Operational Mode password

This is how you change the password for operational mode in the PolyScope X setting.

1. Tap the hamburger menu in the main navigation.
2. Tap Settings.
3. Tap Operational Mode in the Password section.
4. Add the default password, if it is the first time.
5. Add your preferred password, at least 8 characters.

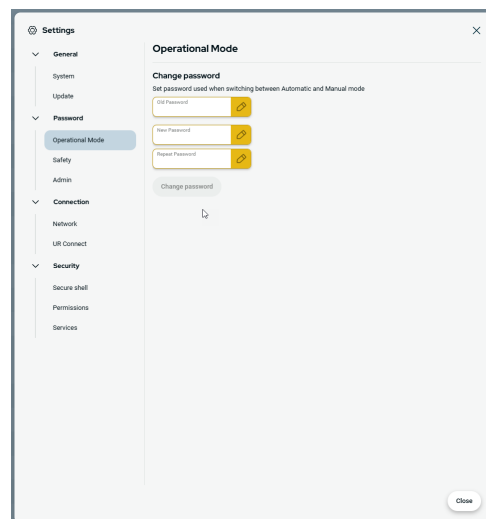

## Password - Safety

**Default Password**

The default password for safety: **ursafe**



**NOTICE**

If you forget your password, it cannot be replaced or recovered. You will have to reinstall the software.

You have to use the default password, when you change the password for the first time.

**Change Safety Password**

This is how you change the safety password in the PolyScope X setting.

1. Tap the hamburger menu in the main navigation.
2. Tap Settings.
3. Tap Safety in the Password section.
4. Add the default password, if it is the first time.
5. Add your preferred password, at least 8 characters.

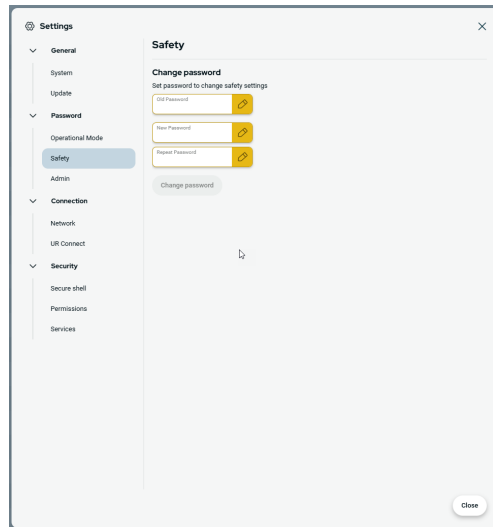

### 10.2.2. Secure Shell (SSH) Access

**Description**

You can manage remote access to the robot using Secure shell (SSH). The Secure shell security settings screen allows administrators to enable or disable SSH access to the robot.

- To enable/disable SSH**
1. Access the Hamburger menu and select **Settings**.
  2. Under Security, tap **Secure shell**.
  3. Enter the password to **unlock** the settings.
  4. Slide the **Enable SSH Access** to the on position.

To the far right of the Enable SSH Access toggle button, the screen shows the port used for SSH communication.

- SSH Authentication**
- Authentication can occur with a password and/or with a pre-shared, authorized key. Security keys can be added by tapping the **Add Key** button and selecting a security key file. Available keys are listed together. Use the trash icon to remove a selected key from the list.

### 10.2.3. Permissions

- Description**
- Access to the Networking, URCap Management and Updating PolyScope X screens is restricted by default, to prevent unauthorized changes to the system. You can change the permission settings to allow access to these screens. An Admin password is required to access Permissions.

- To access Permissions**
1. Access the Hamburger menu and select **Settings**.
  2. Navigate to Security and tap **Permissions**.

- Additional system permissions**
- You can also lock a few important screens/functionalities with the Admin password. On the Permissions screen in Security section in the Settings menu, it is possible to specify which additional screens are to be protected by the Admin password and which screens are available to all users. The following screens/functionalities can optionally be locked:

- Network settings
- Update settings
- URCaps section in the System Manager
- UR Connect

- To enable/disable system permissions**
1. Access Permission as previously described. The protected screens are listed under Permissions.
  2. For the desired screen, slide the On/Off toggle switch to the On position to enable it.
  3. To disable the desired screen, slide the On/Off toggle switch to the Off position.

The screen locks again once the toggle is in the Off position.

## 10.2.4. Services

**Description** Services allow administrators to enable or disable remote access to the standard UR services running on the robot, such as Primary/Secondary Client interfaces, PROFINET, Ethernet/IP, ROS2, etc.

Use the Service screen to restrict remote access to the robot by only allowing external access to the services on the robot which the specific robot application is actually using. All services are disabled by default to provide maximum security. The communication ports for each service are to right of the On/Off toggle button in the list of services.

**Enabling ROS2** When the ROS2 service is enabled on this screen, you can specify the ROS Domain ID (values 0-9). After changing the Domain ID, the system restarts to apply the change.

## 10.3. Unlock Safety Settings

**Description** You have to unlock the safety settings to change them.



**NOTICE**

Safety Settings are password protected.

The default password for safety: **ursafe**.

**Unlock safety settings**

1. In the PolyScope X Main Navigation, tap the Application tab.
2. On the workcell screen tap the Safety icon.
3. Observe that the Robot Limits screen displays, but settings are inaccessible.
4. Enter the safety password and tap UNLOCK to make settings accessible.
5. Tap LOCK or navigate away from the Safety menu to lock all Safety item settings again.

## 10.4. Safety Menu Settings

**Description** The safety system limits are defined in the Safety Configuration. The safety system receives values from the input fields and detects any violation if any the values are exceeded. The robot controller prevents violations by making a robot stop or by reducing the speed.

**CAUTION**

Use of Safety Configuration parameters different from those defined by the risk assessment can result in hazards that are not reasonably eliminated or risks that are not sufficiently reduced.

### 10.4.1. Robot Limits

**Description** Robot Limits restrict general robot movements.

- Change the values in robot limits (Normal and Reduced) and apply to see the applied changes in safety checksum.
- Verify the values of reduced should be always less than the values in Normal.

**NOTICE**

The safety limits restrict forces and motions at the tool flange and the center of the two user-defined tool positions

### Speed Limits

Program name: Default program

Apply | Unlock

35 7a c7 dc

Move

Program structure

Variables

Robot State: Off

Speed: 100%



#### NOTICE

Restricting stopping time and distance affect overall robot speed. For example, if stopping time is set to 300 ms, the maximum robot speed is limited allowing the robot to stop within 300 ms.

Limit	Description
Tool Speed	Limits maximum robot tool speed.
Elbow Speed	Limits maximum robot elbow speed.
Momentum	Limits maximum robot momentum.
Stopping Time	Limits maximum time it takes the robot to stop e.g. when an emergency stop is activated.
Stopping Distance	Limits maximum distance the robot tool or elbow can travel while stopping.

### Power and Force

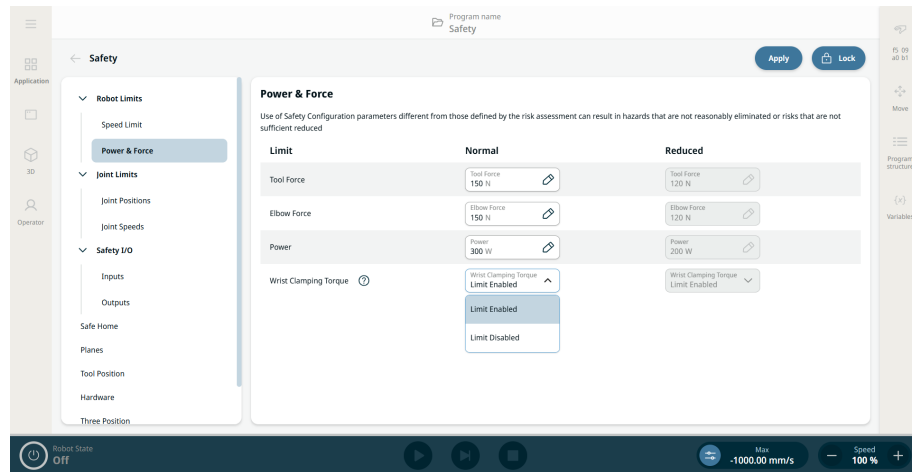

#### NOTICE

The tool and elbow forces may be exceeded by the three wrist joints if the "wrist clamping torque" safety function is disabled

Limit	Description
Tool Force	Limits the maximum force exerted by the robot tool in clamping situations.
Elbow Force	Limits maximum force that the elbow exerts on the environment.
Power	Limits maximum mechanical work produced by the robot in the environment. This limit considers the payload a part of the robot and not of the environment.
Wrist Clamping Torque	Limits how much torque the wrist can apply for pushing. Enabled by default.

### Safety Mode

When no protective stops are active, the safety system operates in a Safety Mode associated with a set of safety limits:

Safety mode	Effect
Normal	This configuration is active by default.
Reduced	This configuration activates when the Tool Center Point (TCP) is positioned beyond a Trigger Reduced mode plane, or when triggered using a configurable input.

### Wrist Clamping Torque Limit

**Description** **Wrist Clamping Torque Limit** is a setting that enables or disables limitation of the maximum clamping torque for the wrist joints of the robot. The limitation is enabled by default. This safety function limits how much torque the wrist can apply when pushing.

**Wrist Clamping Torque Limit details**

When **enabled**, the robot limits torque in the wrist joints to prevent clamping between the wrist, payload, and the lower arm of the robot.

**NOTICE**

When the setting is enabled, it also defines a non-safety-rated upper limit for the applied torque windows of the base, shoulder, and elbow joints. In force control applications, the achievable contact forces may be significantly lower than the specified forces in the **Tool Force Limit** and **Elbow Force Limit** safety functions.

When **disabled**, the robot can use higher pushing force with the wrist joints, for example in force-controlled applications. When the function is disabled, risks of clamping between the wrist, payload, and lower arm of the robot must be mitigated by other means.

**NOTICE**

This safety function is enabled on all robots by default. In PolyScope X version 10.12 and newer, it is possible to disable this safety function.

**Enable and disable Wrist Clamping Torque Limit**

1. Go to the **Application** tab and select **Safety**.
2. Under **Robot Limits**, tap **Power and Force**. Unlock, enter the safety password, and confirm.
3. You can now select **Limit Enabled** or **Limit Disabled** for Normal or Reduced.

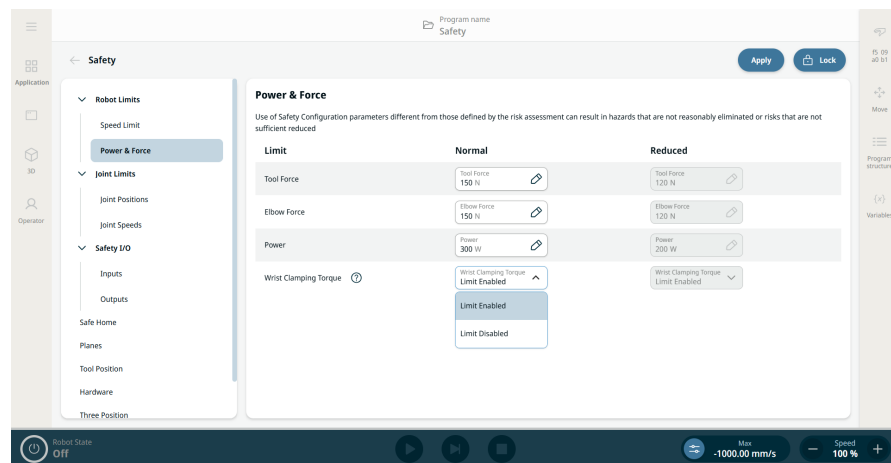

4. Tap **Apply** to apply the safety configuration and restart the safety system.
5. A pop-up box appears where you can revert or confirm the configuration.

Copyright © 2009-2026 by Universal Robots A/S. All rights reserved.

## 10.4.2. Joint Limits

**Description** Joint limits allow you to restrict individual robot joint movements in joint space i.e. joint rotational position and joint rotational speed. Joint limiting can also be called software based axis limiting.

**Joint Positions** This is how you find joint positions and joint speeds.

1. Go to the application.
2. Go to Safety.
3. Select the settings in the left menu.

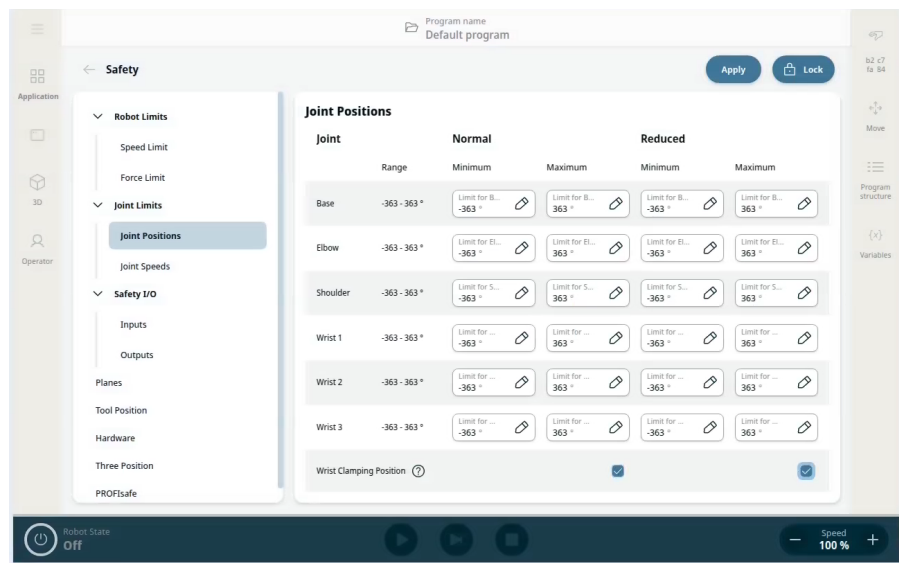

### Joint Speeds

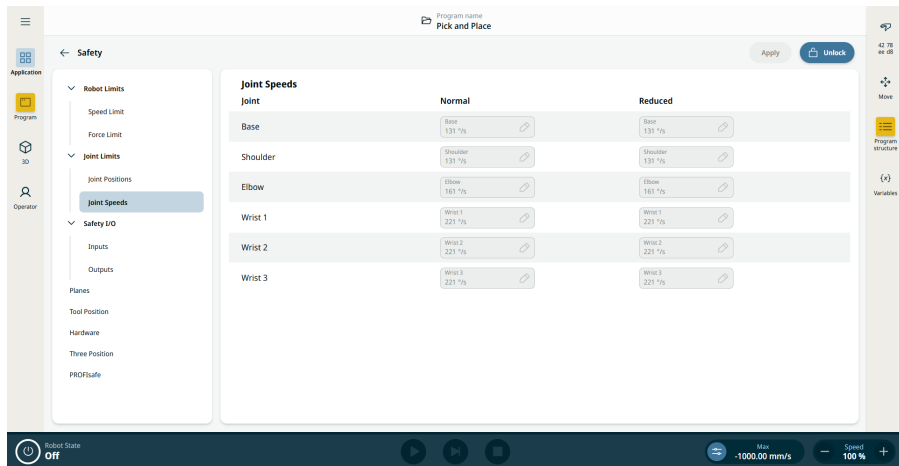

## 10.4.3. Tool Position Restriction

**Description** The Tool Position screen enables users a more controlled restriction of tools and/or accessories placed on the end of the robot arm by letting you define tool positions with a radius that will interact with the safety planes by either collision detection with Tool Position and plane or enter reduced mode when tool enters plane.

**Details** Tool Position has two key benefits:

- Supports two custom configurations to specify where to react to safety planes.
- Visualizes Tool Positions in 3D model.

**NOTICE**

You can define, configure, and manage up to two tool positions.

**User defined tools**

For the user defined tools, the user can change:

- Radius to change the radius of the tool sphere. The radius is considered when using safety planes.
- X, Y, Z positions to change the position of the tool with respect to the tool flange of the robot. The position is considered for the safety functions for tool speed, tool force, stopping distance, and safety planes.

**To access Tool Position**

1. Navigate to **Safety** Application.
2. Tap **Tool Position** in the left panel. On the top right side of the main screen, tap **Unlock** to activate adding tools. Enter the safety password and **Confirm**.

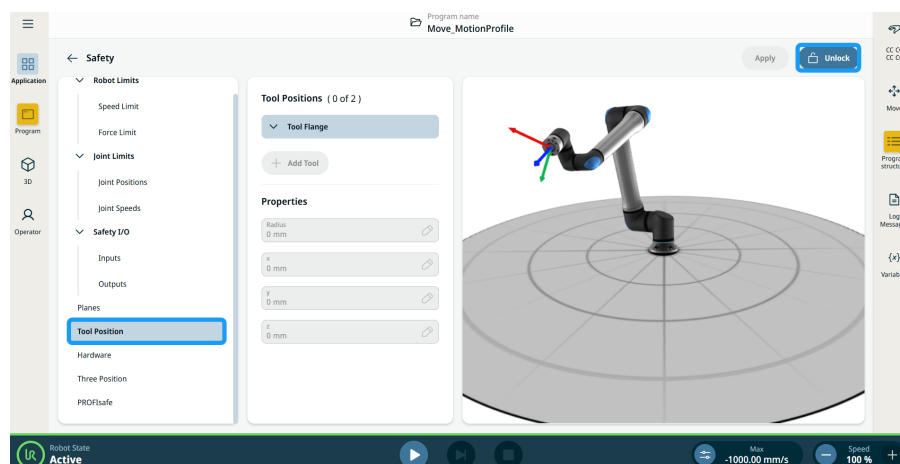

Copyright © 2009-2026 by Universal Robots A/S. All rights reserved.

3. In the central panel's **Tool Positions** column, tap **+ Add Tool**. The added tool, **Tool\_1**, appears under the **Tool Flange tree**.
4. Tap the **kebab icon** of the added tool to rename it to something more identifiable. You can also delete it.

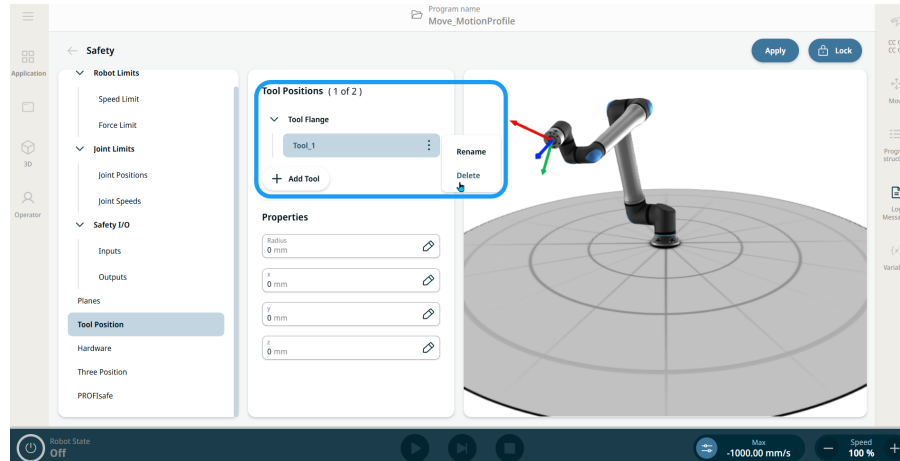

5. In the central panel's **Properties** column, you can find four editable fields for **radius, x, y, and z positions**. Tap the fields to change the radius and x ,y, z coordinates as needed. The sphere in the right panel updates live in the 3D model to assist with accurate placement.
6. Tap **Apply** in the top-right part of the main screen.

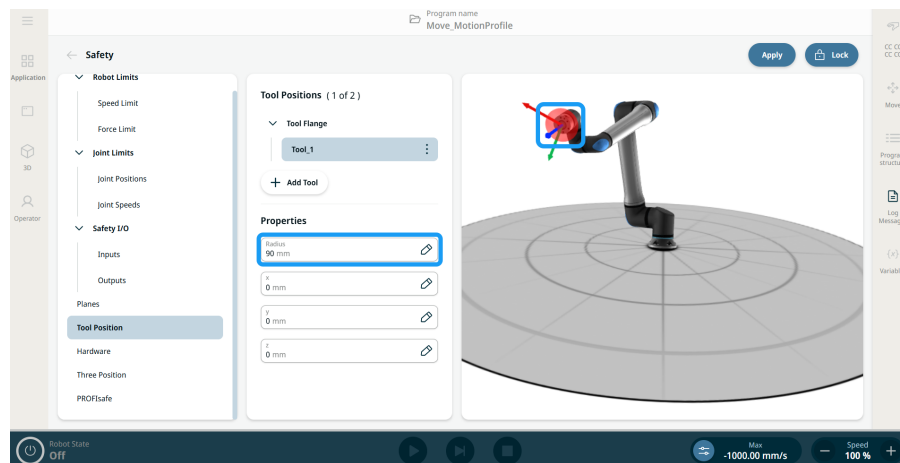

7. The robot will now interact with safety planes when the tool position spheres come into contact with them.

Copyright © 2009-2026 by Universal Robots A/S. All rights reserved.

### 10.4.4. Safety Planes

**Description**

Safety planes restrict robot workspace, the tool, and the elbow.

**WARNING**

Defining safety planes only limits the defined Tool spheres and elbow, not the overall limit for the robot arm.

Defining safety planes does not guarantee that other parts of the robot arm will obey this type of restriction.

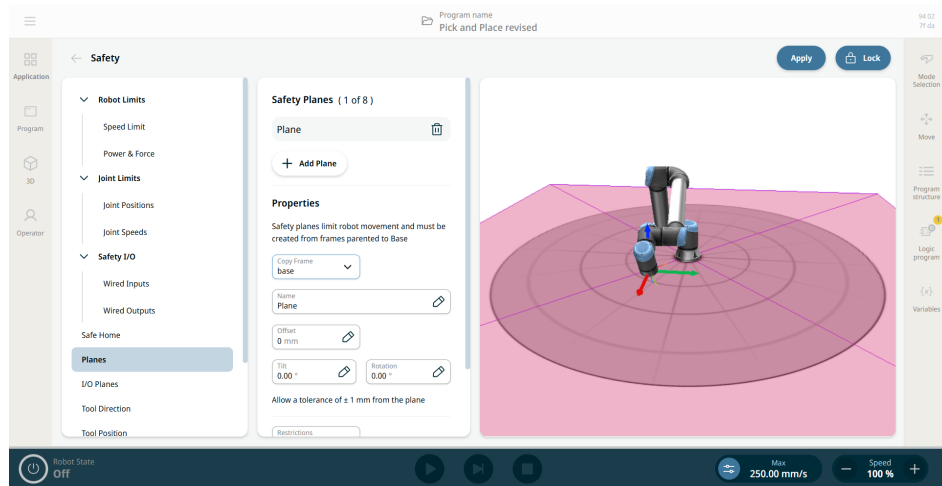

Figure 1.5: PolyScope X screen displaying safety planes.

**Configuring a Safety Plane**

You can configure safety planes with the properties listed below:

- **Name.** This is the name used to identify the safety plane.
- **Offset from base.** This is the height of the plane from the base, measured in the Y direction.
- **Tilt.** This is the tilt of the plane, measured from the power cord.
- **Rotation.** This is the rotation of the plane, measured clockwise.

You can configure each plane with the restrictions listed below:

- **Normal.** When the safety system is in Normal mode, a normal plane is active and it acts as a strict limit on the position.
- **Reduced.** When the safety system is in Reduced mode, a reduced mode plane is active and it acts as a strict limit on the position.
- **Both.** When the safety system is either in Normal or Reduced mode, a normal and reduced mode plane is active and acts as a strict limit on the position.
- **Trigger Reduced Mode.** The safety plane causes the safety system to switch to Reduced mode if the robot Tool or Elbow is positioned beyond it.

**Elbow Joint Restriction**

The feature is enabled by default.

You can use Restrict Elbow to prevent robot elbow joint from passing through any of your defined planes.

Disable Restrict Elbow for elbow to pass through planes.

**Tool Flange Restriction**

Restricting the tool flange prevents the tool flange and the attached tool from crossing a safety plane. When you restrict the tool flange, the unrestricted area is the area inside of the safety plane, where the tool flange can operate normally. The tool flange cannot cross the restricted area, outside of the safety plane. Removing the restriction allows the tool flange to go beyond the safety plane, to the restricted area, while the attached tool remains inside of the safety plane. You can remove the tool flange restriction when working with a large tool off-set. This will allow extra distance for the tool to move. Restricting the tool flange requires the creation of a plane feature. The plane feature is used to set up a safety plane later in the safety settings.

**Create Safety Plane Using a Frame**

**Description**

You can use an existing frame to define a safety plane. This provides a more intuitive way to specify plane parameters from a predefined position and rotation (X, Y, Z, RX, RY, RZ). Select the frame in the **Copy Frame** drop-down menu.

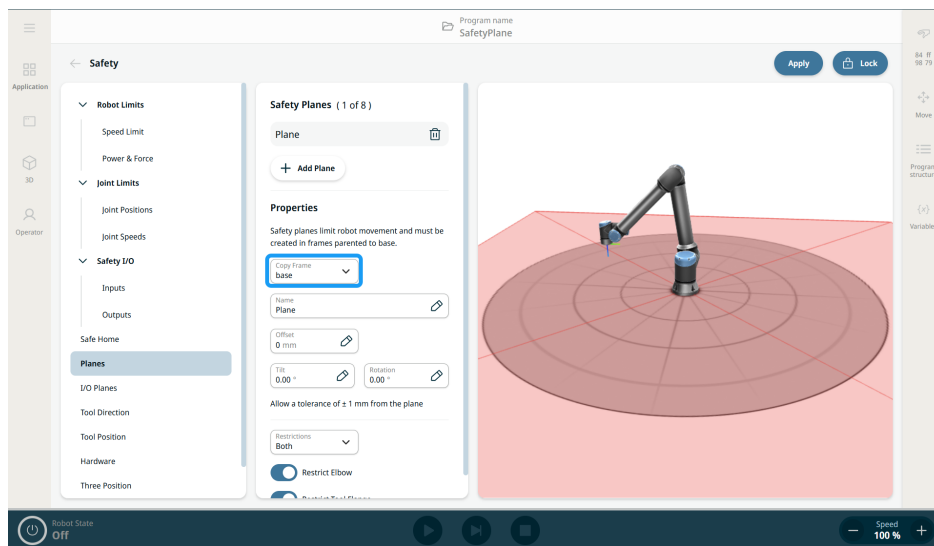

The **Copy Frame** drop-down menu is found in the parameters of a safety plane definition on the **Planes** screen. This list includes frames defined on the **Frames** screen. When you select a frame, it is used as the safety plane definition. If you specify offset, tilt, and rotation parameters, they are applied to the selected frame (see "Configuring a Safety Plane"). The resulting safety plane combines all parameters.

See the "Frames" section in Software Handbook.

### Creating Safety Planes using Frames

1. In the **Application** tab, select **Frames**.
2. Tap **+ Add Frame** under **Custom Frames**, then rename the frame using the **three vertical dots (kebab icon)**.

**NOTICE**  
 Frames are created relative to **Base**.

3. In the **Parent** field, select **Base**.

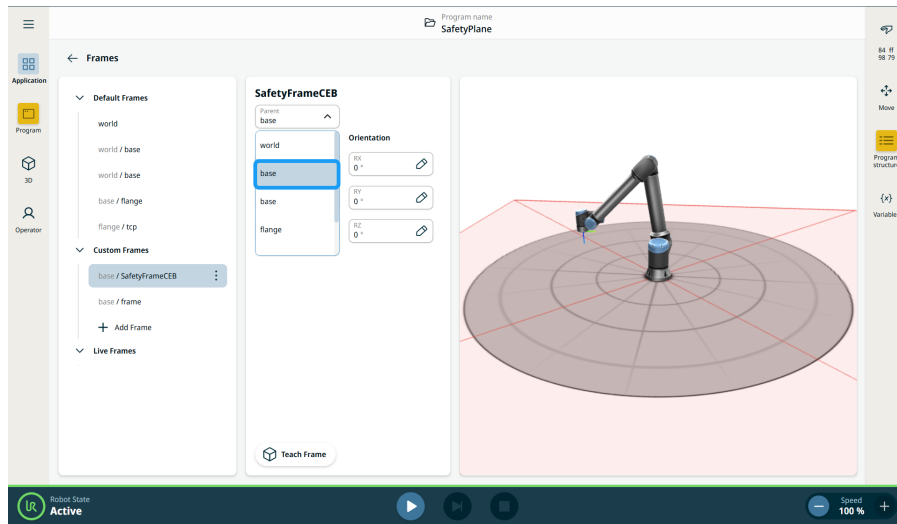

### Selecting Reference Frame in Safety Plane

1. In the **Application**, go to **Safety**, select **Planes** and tap **Unlock**.
2. On the **Safety Planes** screen, select a frame in the **Copy Frame** drop-down menu. You can also apply offset, tilt, and rotation.

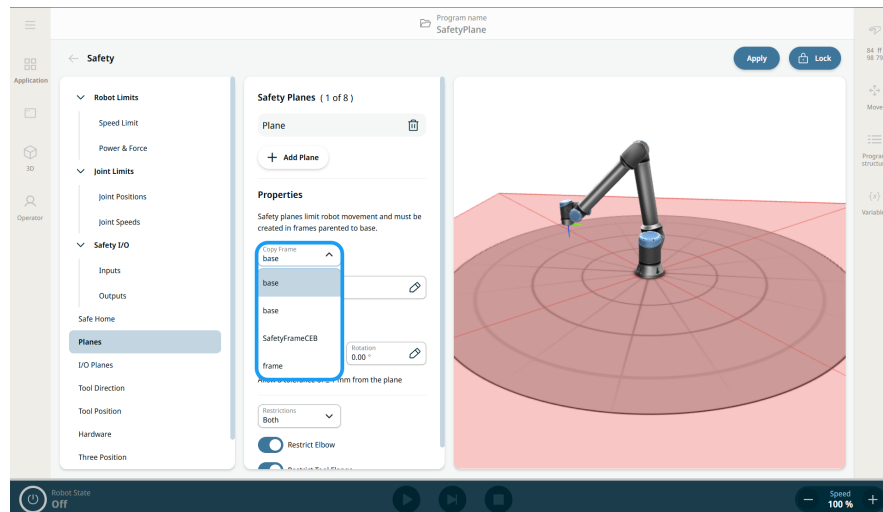

3. Tap the **Apply** button.

Copyright © 2009-2026 by Universal Robots A/S. All rights reserved.

- Configured planes are listed in the function assignment table on the **Confirmation of Applied Safety Configuration** overview dialog.

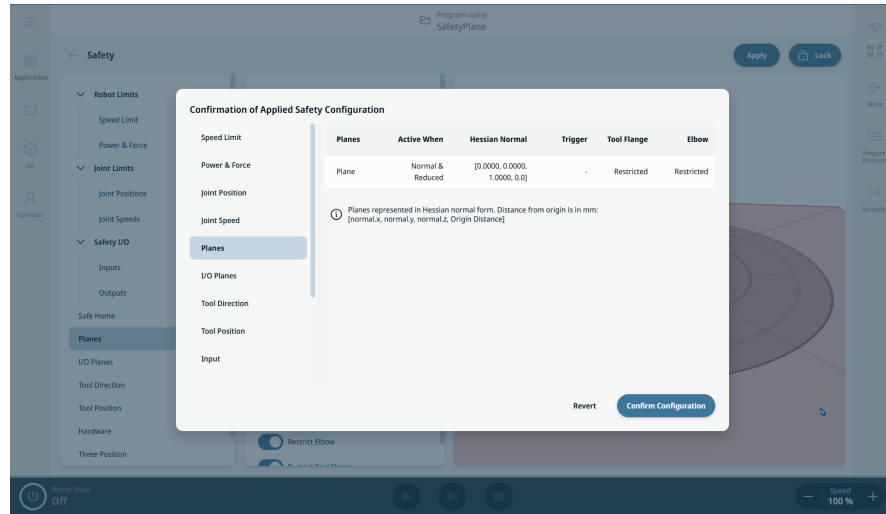

**NOTICE**

A frame used for a safety plane may be inverted from what you expect. If the robot is positioned on the violating side of the plane, add a tilt of 180 degrees.

For restrictions on plane configurations, elbow joint restriction, and tool flange restriction, see "Safety Planes".

10.4.5. I/O Planes

**Description**

The **I/O Planes** feature provides more flexible use of safety planes compared to the standard **Safety Planes** functionality. It lets you activate and deactivate safety planes using terminal inputs, and/or generate an output signal when the safety spheres cross a safety plane.

**Input/Stop Plane**

**Trigger Stop** triggers an I/O plane stop. It can be muted using a safety input. Unless muted, moving toward the plane causes the robot to stop and wait until the safety input mutes the plane.



**NOTICE**

When the plane is inactive, the robot is allowed to move freely. When the plane is active and the robot has not crossed the plane, the robot will stop before crossing the plane. If the plane is activated, while the robot is moving on the edge of the plane, the robot can end up crossing the plane and will in worst case stop according to the configured distance and stopping time limits. When the plane is activated and the robot has crossed the plane, the robot will stop according to the configured stopping distance and stopping time limits.

1. Go to **Safety** in the **Application tab** and tap **I/O Planes**.

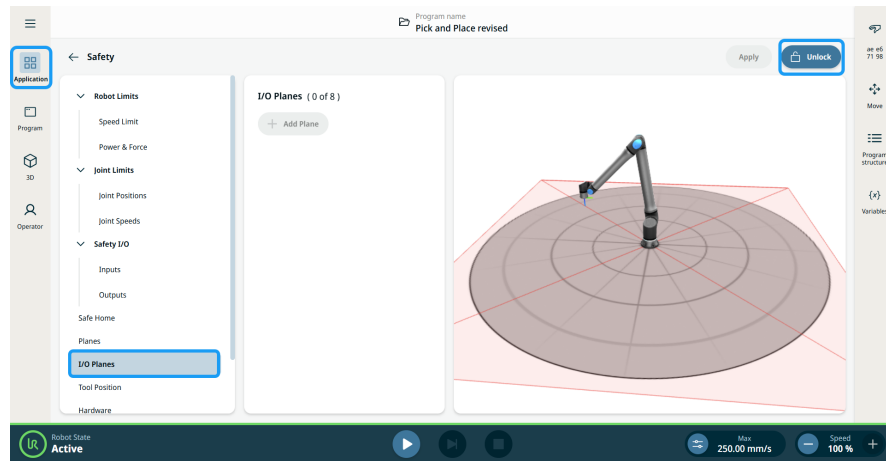

2. **Unlock** and tap **Add Plane**. Several fields and tabs of the I/O Planes properties appear.

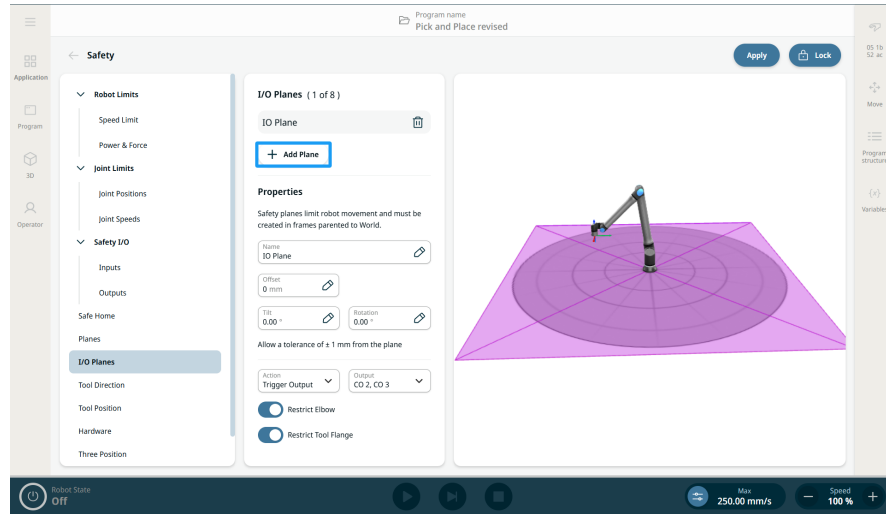

3. Enter the value of **Offset** and **Tilt**.
4. In the **Action** field, select **Trigger Stop**.
5. In the **Muting Input** field, select **CI4** and **CI5**. Tap **Apply**.

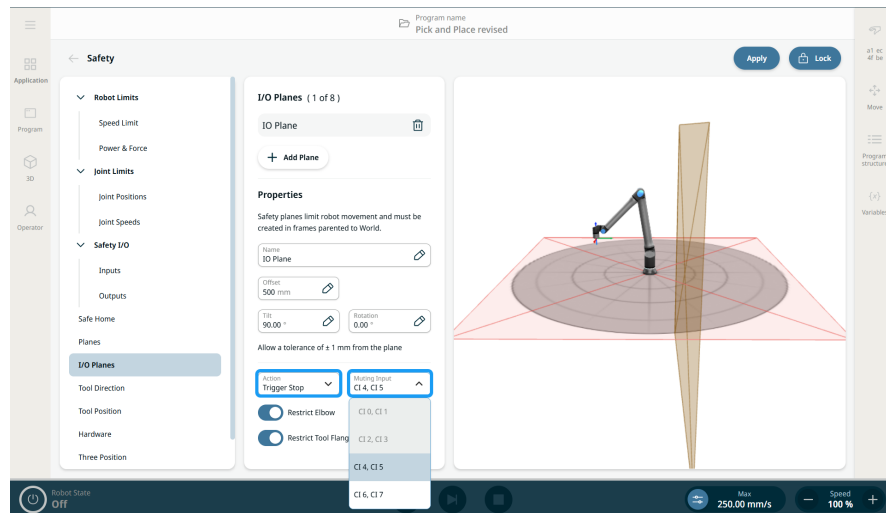

6. When you toggle a physical switch connected to the input, the plane disappears from the 3D viewer. Tap the **Play** button, and the robot moves freely from one side of the plane to the other.
7. Toggle the switch again to unmute the plane, and the robot enters I/O stop.

Copyright © 2009-2026 by Universal Robots A/S. All rights reserved.

## Output Plane

**Trigger Output** generates a safety output based on whether one or more of the safety spheres have crossed the plane.

When one or more of the safety spheres have crossed a plane defined as trigger output, the safety output corresponding to that plane is activated. "Activated" means that the safety outputs are electrically set "Low".



### NOTICE

When any of the safety spheres has crossed a plane defined as trigger output, the safety output corresponding to that plane is activated.

1. Enter the value of **Offset** and **Tilt**.
2. In the **Action** field, select **Trigger Output**.
3. In the **Output** field, select **CO2, CO3**. Tap **Apply**.

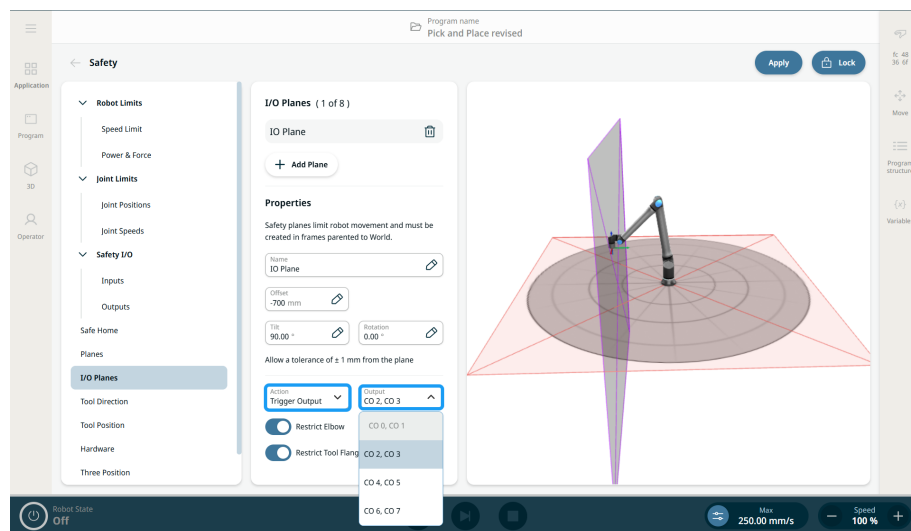

4. When you play the robot program, you can see the "LOW" and "HIGH" outputs in the [Communication](#) tab.

## 10.4.6. Hardware

**Description** The **Hardware** section allows users to select the type of Teach Pendant (TP) connected to their robot. Available options are:

- **3PE Enabled.** 3-Position Enabling Teach Pendant (3PE TP)
- **None.** This allows the robot to be safely powered up without a Teach Pendant connected to the Control Box.



**NOTICE**

For safety reasons, the robot will not start if the selection does not reflect the connected hardware.

**Purpose of None option** The **None** option supports setups where a Teach Pendant is not required or physically present, enabling more streamlined and flexible deployments, especially in automated or remote-controlled environments.

It gives users three key benefits:

- Supports headless configurations where no Teach Pendant is used.
- Simplifies hardware requirements for minimal setups.
- Improves start-up flexibility by removing dependency on Teach Pendant presence.

**To access None**

1. Tap **Hardware** on the left panel of the Safety application screen.
2. Unlock the main screen in the topmost right part, enter your safety password, and **Confirm**.
3. On the central panel, tap the **Teach Pendant** field, and choose **None**.

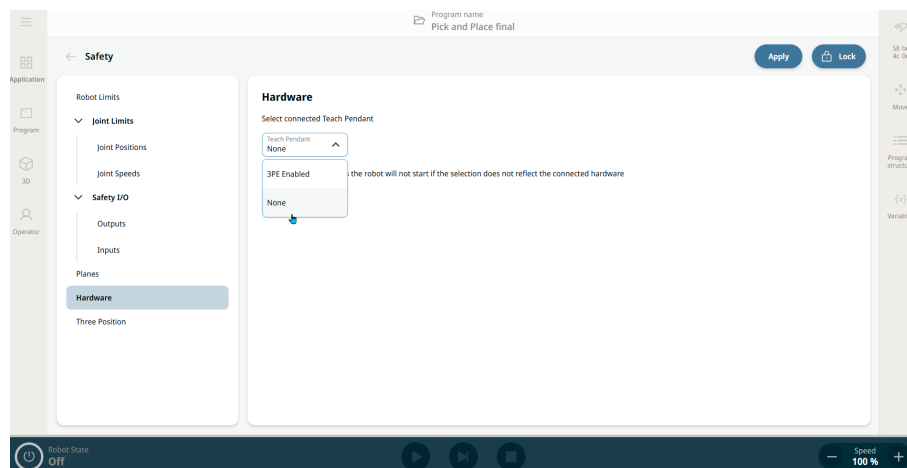

4. Tap **Apply** beside the Lock button in the main screen.
5. Tap **Apply and restart** in the pop-up of Apply Safety Configuration.
6. A Confirmation of Applied Safety Configuration pop-up screen appears, and you can either **Revert** or **Confirm Configuration**.

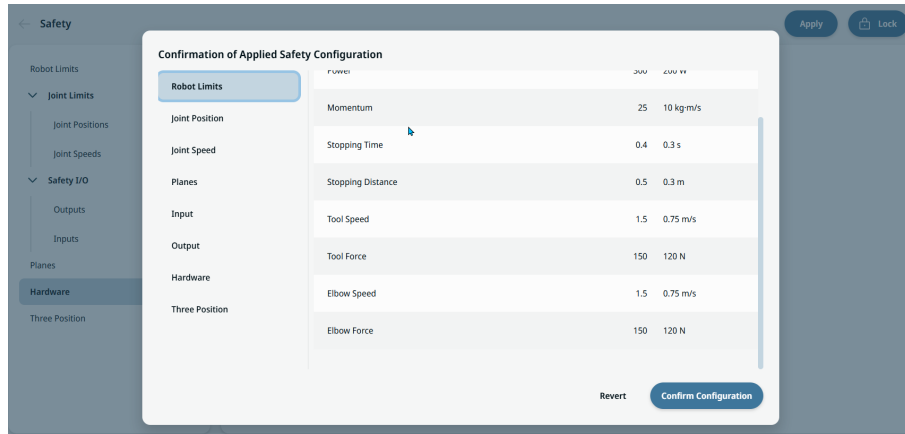

### 10.4.7. Three Position

**Description**

Manual high speed allows both tool speed and elbow speed to temporarily exceed 250 mm/s. It is only available when your robot is on manual mode and a three-position enabling device is configured. If there is no interaction with the three-position enabling device in five minutes, increased values will be reset to 250 mm/s.

**To access Three Position**

1. On the left panel, tap **Three Position**.
2. Tap **Unlock** on the upper right side of the main screen.
3. Enter the safety password and **Confirm**.
4. On the central panel, slide on the button to **Allow manual high speed**.
5. Tap **Apply** on the upper right side of the main screen.

### 10.4.8. PROFIsafe

**Description**

The PROFIsafe network protocol (implemented as version 2.6.1) enables the robot to communicate with a safety PLC according to ISO 13849, Cat 3 PLd requirements. The robot transmits safety-related information to a safety PLC and receives safety-related information.

The safety-related communications can be state messages or to trigger a safety function (e.g. reduced settings, stop). Stop commands are described according to IEC 60204-1, where the emergency stop is a Category 1 stop and the safeguard stop is a Category 2 stop.

The PROFIsafe interface provides a safe, network-based alternative to connecting wires to the safety IO pins of the robot control box.

Use of the PROFIsafe interface maintains the UR robot's functional safety specifications (PL, category, and PFH). For details, see the "Safety Functions Table" section in the UR manual. For example, the "safeguard stop" is PLd Category 3 with a PFH value less than 1,8E-07 (1.8 x 10<sup>-7</sup>).

PROFIsafe is only available on robots that have an enabling license, which you can obtain by contacting your local sales representative. After you obtain the license, download it from [myUR](#).

Please refer to "Robot Registration and URCap License files" for information regarding robot registration and license activation.

---

**Safety  
PLC Out**

A control message that the safety PLC sends to the robot contains the information shown in the following table.

Signal	Description
E-Stop by system	<ul style="list-style-type: none"> <li>• 0: Asserts the system e-stop.</li> <li>• 1: Clear system e-stop.</li> </ul>
Safeguard stop	<ul style="list-style-type: none"> <li>• 0: Asserts the safeguard stop.</li> <li>• 1: Normal operation state.</li> </ul> <p><b>Note:</b> Also refer to the "Reset safeguard stop" signal description.</p>
Reset safeguard stop	Resets the safeguard stop state on a 0-to-1 transition when the "safeguard stop" signal is already set to 1.
Safeguard stop auto	<ul style="list-style-type: none"> <li>• 0: Asserts safeguard stop if the robot is operating in Automatic mode.</li> <li>• 1: Normal operation state.</li> </ul> <p>Safeguard stop auto shall only be used when a 3-Position Enabling (3PE) Device is configured. If no 3PE Device is configured, the safeguard stop auto acts as a normal safeguard stop input.</p> <p><b>Note:</b> Also refer to the "Reset safeguard stop auto" signal description.</p>
Reset safeguard stop auto	Resets the safeguard stop auto state on a 0-to-1 transition when the "safeguard stop auto" signal is already set to 1.
Reduced	<ul style="list-style-type: none"> <li>• 0: Activates the Reduced safety limits.</li> <li>• 1: Activates the "Normal mode" safety limits.</li> </ul> <p>The safety system guarantees the robot is within reduced limits less than 0.5s after the input is activated. If the robot arm continues to violate any of the reduced limits, a Stop Category 0 is triggered.</p>
Operational mode	<ul style="list-style-type: none"> <li>• 0: Activates the manual operational mode.</li> <li>• 1: Activates the automatic operational mode.</li> </ul> <p>If the safety configuration "Operational mode selection via PROFIsafe" is disabled, this field shall be omitted from the PROFIsafe control message.</p>

**Safety PLC In** A status message that the robot sends to the safety PLC contains the information shown in the following table.

Signal	Description
Stop, cat. 0	<ul style="list-style-type: none"> <li>0: Robot is performing, or has completed, a safety stop of category 0; a hard stop by immediate removal of power to the arm and the motors.</li> <li>1: Normal operation state.</li> </ul>
Stop, cat. 1	<ul style="list-style-type: none"> <li>0: Robot is performing, or has completed, a safety stop of category 1; a controlled stop after which the motors are left in a power-off state with brakes engaged.</li> <li>1: Normal operation state.</li> </ul>
Stop, cat. 2	<ul style="list-style-type: none"> <li>0: Robot is performing, or has completed, a safety stop of category 2; a controlled stop after which the motors are left in a power-on state.</li> <li>1: Normal operation state.</li> </ul>
Violation	<ul style="list-style-type: none"> <li>0: Robot is stopped because the safety system has failed to comply with the active safety limits defined.</li> <li>1: Normal operation state.</li> </ul>
Fault	<ul style="list-style-type: none"> <li>0: Robot is stopped because of an unexpected exceptional error in the safety system.</li> <li>1: Robot is not experiencing an unexpected exceptional error in the safety system.</li> </ul>
E-stop by system	<ul style="list-style-type: none"> <li>0: Robot is stopped because of one of the following conditions:                             <ul style="list-style-type: none"> <li>A safety PLC connected via PROFIsafe has asserted a system level e-stop.</li> <li>An IMMI module connected to the control box has asserted a system level e-stop.</li> <li>A unit connected to the system e-stop configurable safety input of the control box has asserted a system level e-stop.</li> </ul> </li> <li>1: Robot is not in system e-stop.</li> </ul>
E-stop by robot	<ul style="list-style-type: none"> <li>0: The robot is stopped because of one of the following conditions:                             <ul style="list-style-type: none"> <li>The e-stop button of the teach pendant is pressed.</li> <li>An e-stop button connected to the robot e-stop non-configurable safety input of the control box is pressed.</li> </ul> </li> <li>1: Robot is not in e-stop by robot.</li> </ul>

Signal	Description
Safeguard stop	<ul style="list-style-type: none"> <li>0: The robot is stopped due to one of the following conditions: <ul style="list-style-type: none"> <li>A safety PLC connected via PROFIsafe has asserted the safeguard stop.</li> <li>A unit connected to the safeguard stop nonconfigurable input of the control box has asserted the safeguard stop.</li> <li>A unit connected to the safeguard stop configurable safety input of the control box has asserted the safeguard stop.</li> </ul> </li> <li>1: The robot is not stopped due to a safeguard stop.</li> </ul> <p><b>Note:</b> Also refer to the “Reset safeguard stop” signal description. PROFIsafe enforces the use of the safeguard reset functionality.</p>
Safeguard stop auto	<p>0: The robot is stopped because it is operating in Automatic mode and one of the following conditions applies:</p> <ul style="list-style-type: none"> <li>A safety PLC connected via PROFIsafe has asserted safeguard stop auto.</li> <li>A unit connected to a safeguard stop auto configurable safety input of the control box has asserted safeguard stop auto.</li> </ul> <p>1: The robot is not stopped due to safeguard stop auto.</p> <p><b>Note:</b> Also refer to the “Reset safeguard stop auto” signal description. PROFIsafe enforces the use of the safeguard reset functionality.</p>
3PE stop	<ul style="list-style-type: none"> <li>0: The robot is stopped because it is operating in Manual mode and one of the following conditions applies: <ul style="list-style-type: none"> <li>Any 3PE is pressed to the middle position, and Freedrive input is active.</li> <li>Not all 3PE devices are pressed to the middle position.</li> </ul> </li> <li>1: Robot is not stopped because of a 3-position enabling device.</li> </ul>
Operational mode	<p>Indication of the active operational mode of the robot.</p> <ul style="list-style-type: none"> <li>0: Disabled</li> <li>1: Automatic</li> <li>2: Manual</li> </ul>
Reduced	<ul style="list-style-type: none"> <li>0: Reduced safety limits are active.</li> <li>1: Normal safety limits are active.</li> </ul>

Signal	Description
Active limit set	<p>The active set of safety limits.</p> <ul style="list-style-type: none"> <li>• 0: Normal</li> <li>• 1: Reduced</li> <li>• 2: Recovery</li> </ul>
Robot moving	<ul style="list-style-type: none"> <li>• 0: Robot is moving. If any joint moves at a velocity of 0.02 rad/s or higher, the robot is considered in motion.</li> <li>• 1: Robot is at standstill.</li> </ul>
Safe home position	<ul style="list-style-type: none"> <li>• 0: Robot is at rest (robot not moving), and in the position defined as the Safe Home Position.</li> <li>• 1: Robot is not at rest, or not in the position defined as the Safe Home Position.</li> </ul>

### Configuring PROFIsafe

1. On the Safety application screen, tap **PROFIsafe** on the left panel.
2. Tap **Unlock** on the top right main screen to enable PROFIsafe. Enter the safety password and **Confirm**.

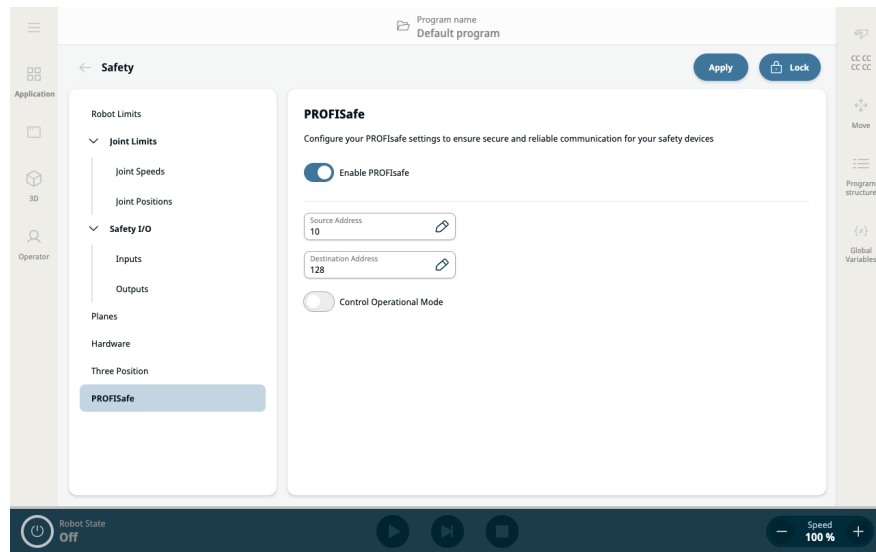

The right panel shows two fields and two buttons for configuring PROFIsafe:

- Enable PROFIsafe button
  - Source Address field
  - Destination Address field
  - Control Operational Mode
3. Slide right the **Enable PROFIsafe** button.
  4. Tap the **Source Address** and **Destination Address** fields to specify the addresses to be used by the robot and the safety PLC in identifying each other.
  5. By tapping **Control Operational Mode**, you have the option to enable the PROFIsafe PLC to control the robot operational mode.

**NOTICE**

In order to configure and use PROFIsafe, **Profinet Device** must be enabled in the security services settings menu.

Enable PROFINET in Settings / Security / Services

**PROFINET has to be enabled**

Read for details and interface location "Profinet".

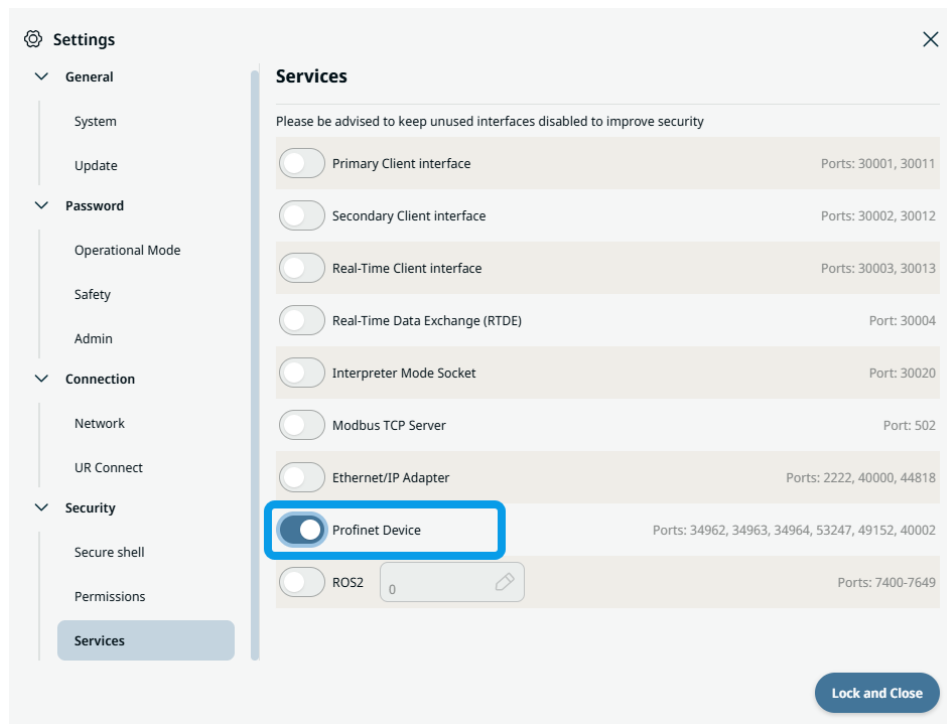

Copyright © 2009-2026 by Universal Robots A/S. All rights reserved.

### 10.4.9. Safe Home

**Description**

**Safe Home** is a PolyScope X feature that enables users to define a safety-related output that activates when the robot reaches the configured safe home position. The user chooses **Home** in the dropdown of available smart skill positions, which can be assigned as the reference for the Safe Home position.

Access Safe Home

1. Tap the **Application Tab** and choose **Safety Application**. In the left panel, choose **Safe Home**.

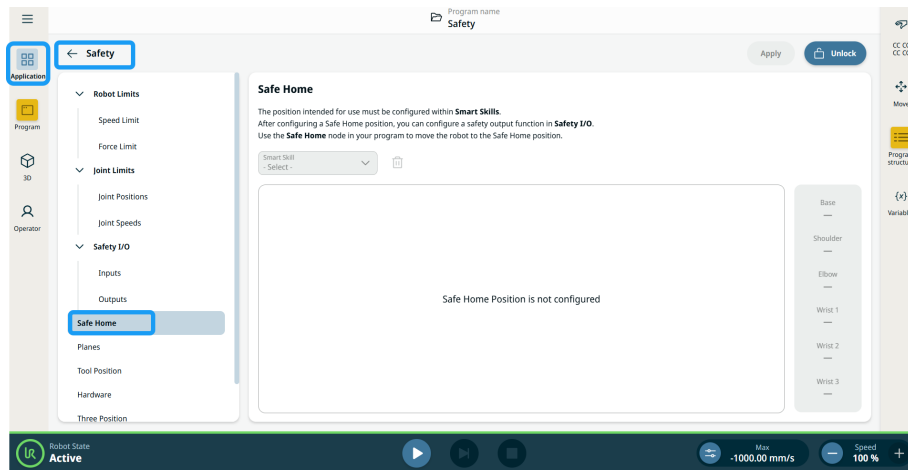

2. To configure the robot position, go to **Smart Skills Application** and choose **Home**.
3. Tap the **Edit Pose** button, and the 3D view of the robot arm appears.

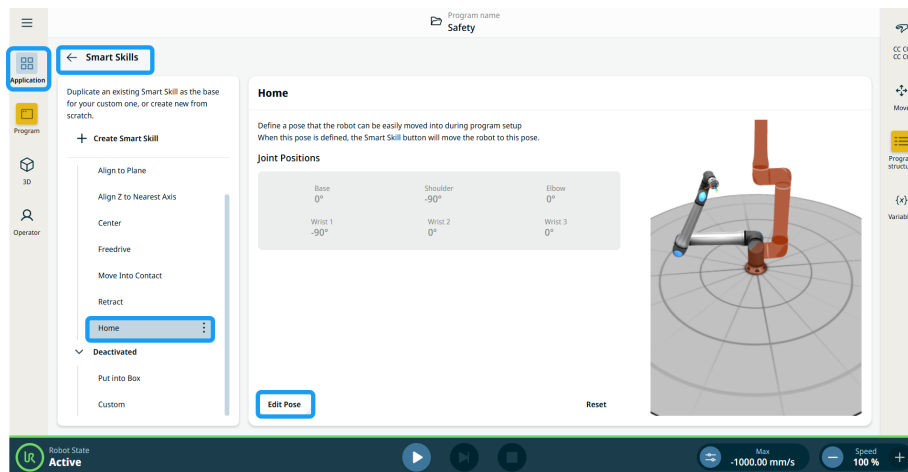

4. Jog the robot to the intended position using the **Move, Joints, TCP** buttons.
5. Long press the yellow **Move Here** button until the previewed image is positioned to the new configuration.
6. Tap **Save** to finalize the configuration.

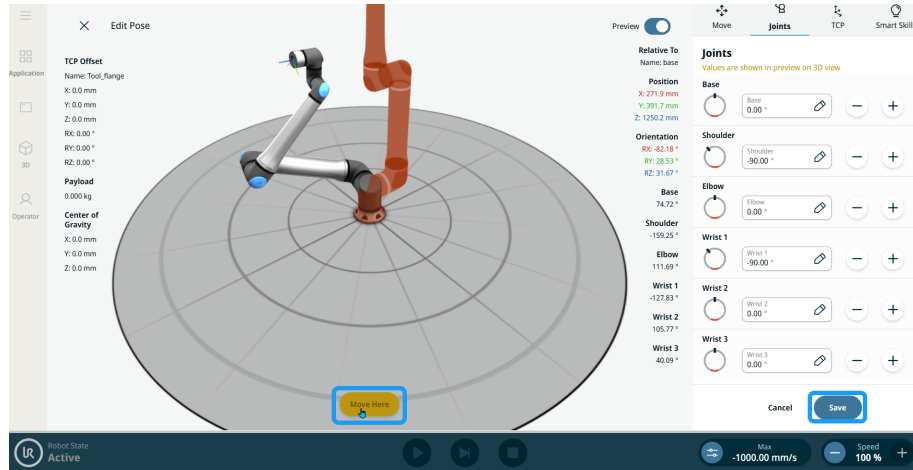

7. Go back to **Safe Home** in **Safety Application** and enter the safety password.
8. In the activated **Smart Skill** field, select **Home**, and the configured robot position appears in the main screen.
9. Tap **Apply** and choose **Apply and restart**. Then tap **Confirm Configuration**.

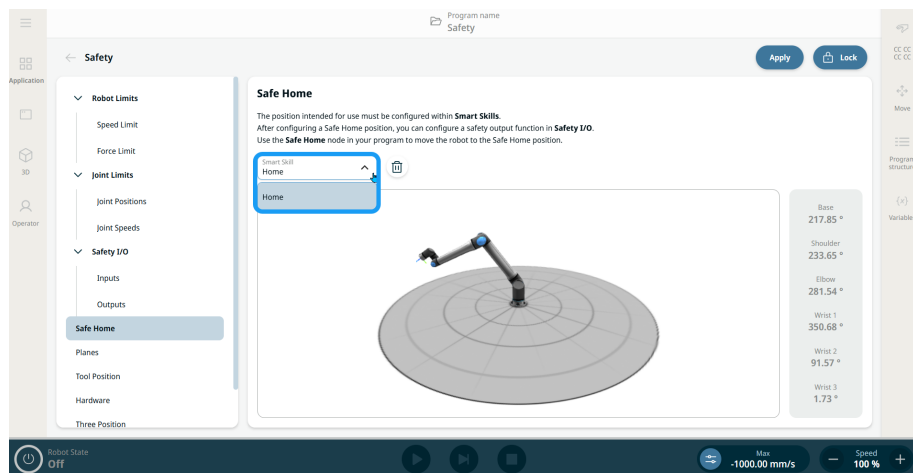

Copyright © 2009-2026 by Universal Robots A/S. All rights reserved.



**NOTICE**

If the Position Smart Skill is selected as the position reference for Safe Home:

- The message box is displayed on the Position Smart Skill page.
- The Position Smart Skill configured as Safe Home cannot be renamed, edited, or deleted unless the user deletes or unassigns the Safe Home from the **Safety > Safe Home** screen.

10. In the Smart Skills screen, the Home position can be duplicated and edited. All the newly created Smart Skills are also available to be configured as Safe Home.

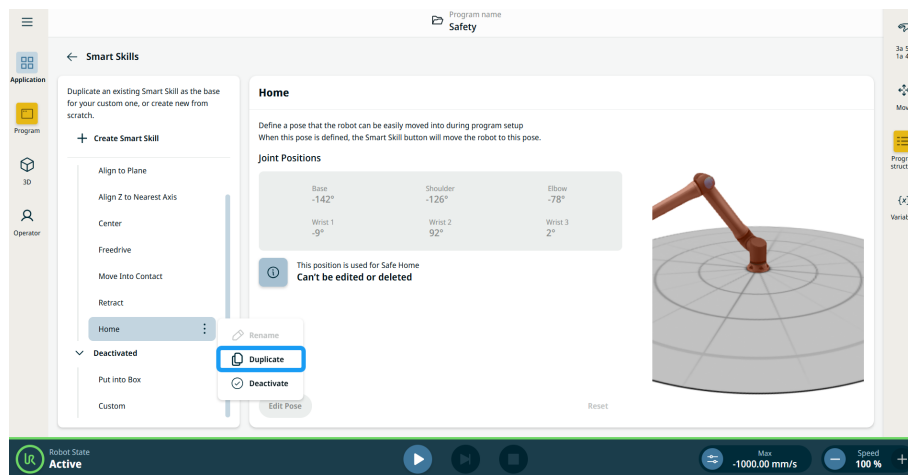

**Safe Home function in outputs**

If the **Home** position is assigned to a position smart skill in **Safety**, the safety output function dropdown contains **Safe Home** as a new function assignment. Choose **Safe Home** in the **Function** fields in **Outputs** of Safety I/O.

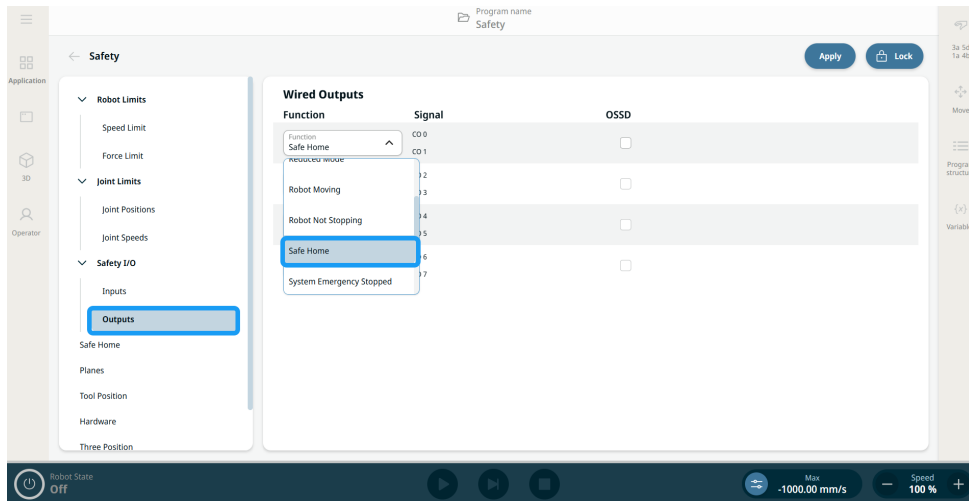

**Safe Home** can be seen in the table of function assignment on the **Confirmation of Applied Safety Configuration** overview dialog.

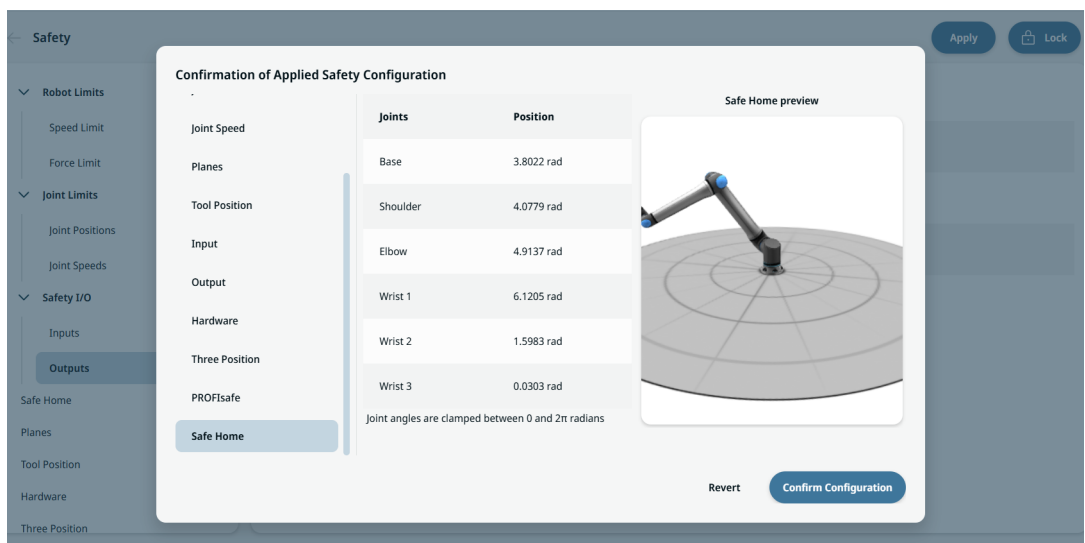

Copyright © 2009-2026 by Universal Robots A/S. All rights reserved.

**Safe Home as a program node**

The **Safe Home** program node is located under the **Move nodes** category within the **Command Nodes**. This node is used to command the robot to move to its predefined safe home position, as configured in the safety application settings for safe home.

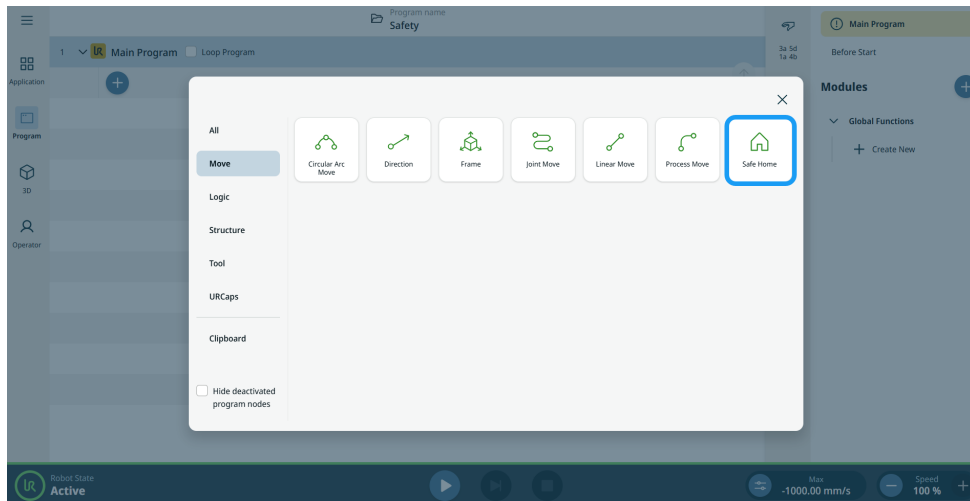

**NOTICE**

Adding the node without a safe home position configured in safety will mark the node as yellow.

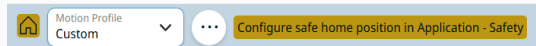

The Safe Home command node has motion profiles options and other advanced settings



when the ellipsis icon is tapped.

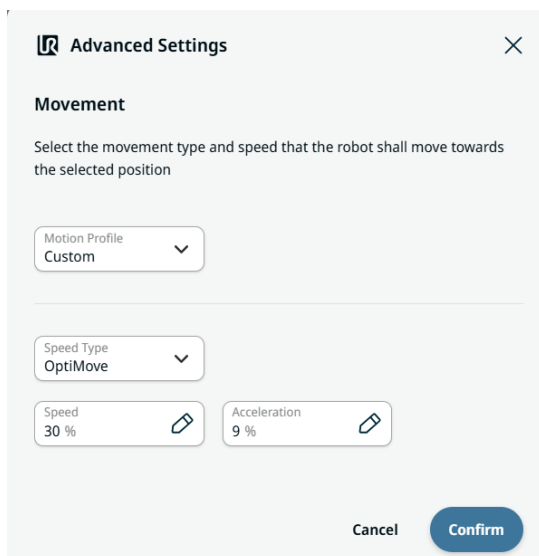

**Advanced Settings**

Users can create movement profiles in the Advanced Settings using the two tabs and two fields:

- Motion Profile
- Speed Type
- Speed tab
- Acceleration tab

**Motion Profile** is a feature enabling users to set predefined motion profiles in move nodes: Joint Move, Linear Move, Circular Arc Move, Process Move, and Direction. **Custom** Motion Profile enables users to define movement data in move node.

In the **Speed Type** field, **OptiMove** is the default option. Choose **Classic** movement if you want to input speed and acceleration in degrees per second or mm per second. OptiMove settings are specified in percent to simplify the usage and setup.

Users can configure the percentage of preferred speed in the **Speed tab**, which sets the target travel speed as a percentage of the robot's maximum speed capability.

Users can configure the percentage of preferred acceleration in the **Acceleration tab**, which sets the target torque limits during acceleration and deceleration as a percentage of the robot's maximum power.

---

#### 10.4.10. Tool Direction

---

**Description**

The Tool Direction screen enables you to configure a safety feature that restricts the angle at which the tool is allowed to point. You can see the Tool Direction limit, which is added to the safety settings. The limit is defined by a cone that has a fixed orientation relative to the robot arm's base reference frame. As the robot arm moves around, the tool direction is restricted so it remains within the defined cone.



**NOTICE**

The restrictions can be disabled or configured to apply in Reduced mode, Normal mode, or both.

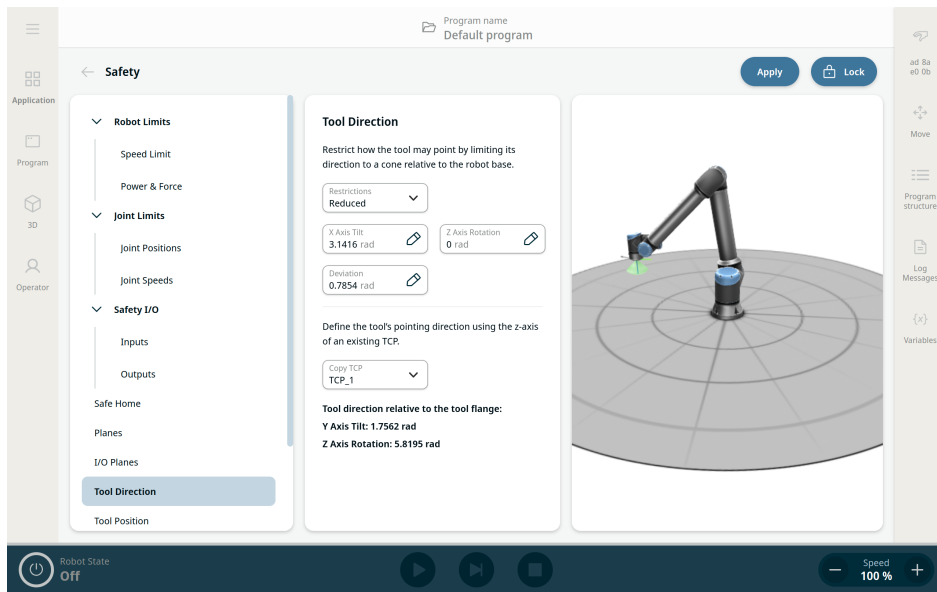

**NOTICE**

The Tool Direction feature enables you to increase the safety of an application when you use a tool that can cause harm or injury when facing in a particular direction.

**Limit Properties**

The Tool Direction limit has three configurable properties:

1. **Tilt:** You can define the cone’s opening angle from the central (reference) direction.
2. **Rotation:** You can define how the cone rotates around its central axis.
3. **Deviation:** You can define the maximum angular offset that is allowed between the desired direction and any direction inside the cone.

Disabled Tool direction limit	Never active
Normal Tool direction limit	Active only when safety system is in <b>Normal mode</b>
Reduced Tool direction limit	Active only when the safety system is in <b>Reduced mode</b>
Both (Normal and Reduced Tool direction limit)	Active when the safety system is in <b>Normal mode</b> as well as when it is in <b>Reduced mode</b> .

The tool’s pointing direction is specified using a TCP configured in the **End Effectors application** settings.

**Tool Properties**

By default, the tool points in the same direction as the Z axis of the tool output flange. You can modify it by specifying two angles:

- **Tilt angle:** How much to tilt the Z axis of the output flange towards the X axis of the output flange.
- **Z-axis rotation:** How much to rotate the tilted Z axis around the original output flange Z axis.

Alternatively, you can copy the Z axis of an existing TCP by selecting that TCP from the drop-down menu.

To access Tool Direction

1. Tap the **Application Tab** and select **Safety Application**. In the left panel, select **Tool Direction**.

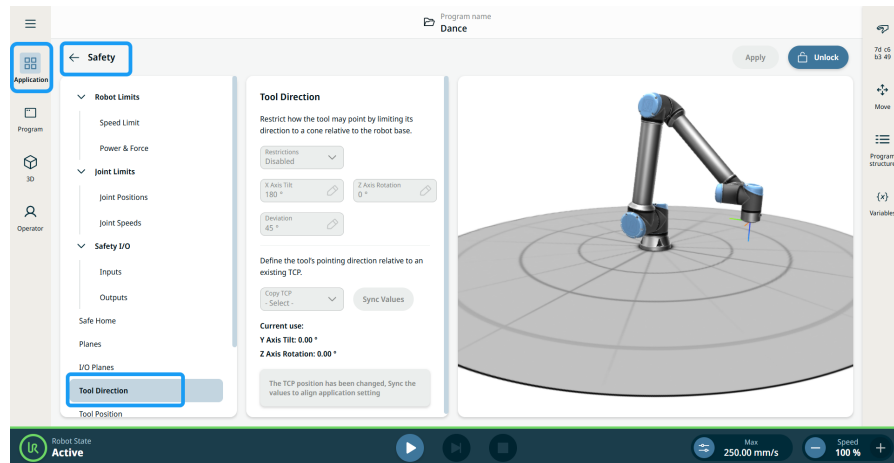

2. **Unlock** and enter the Safety password.
3. When you enable the **Restrictions** field, the other fields become available. A green cone appears in the TCP, showing the tool's pointing direction.

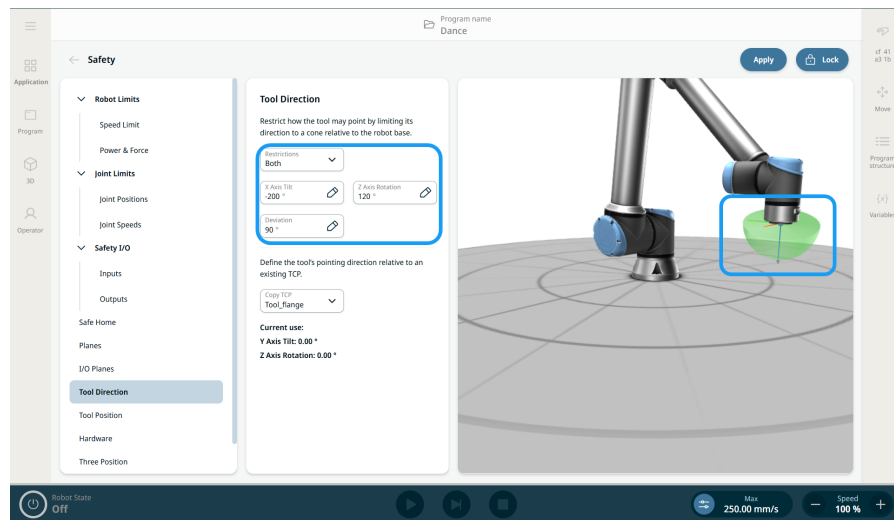

4. Tap the **Apply** button.
5. You can see **Tool Direction** in the function assignment table on the **Confirmation of Applied Safety Configuration** overview dialog.

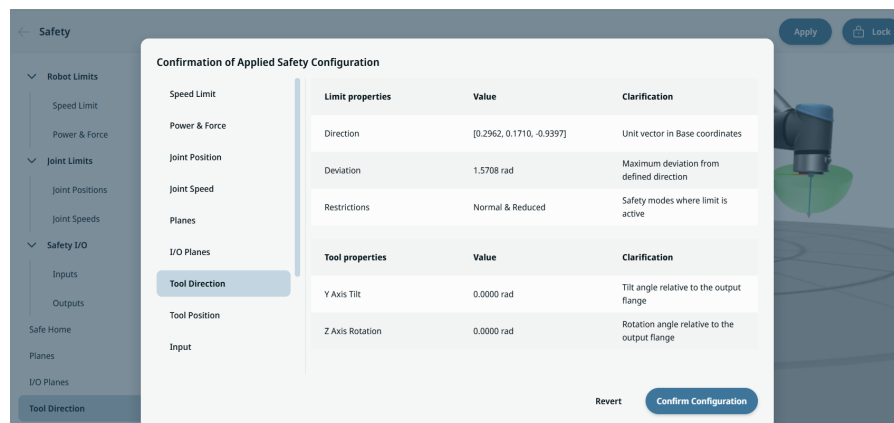

Copyright © 2009-2026 by Universal Robots A/S. All rights reserved.



# 11. Cybersecurity Threat Assessment

**Description** This section provides information to help you strengthen the robot against potential cybersecurity threats. It outlines requirements for addressing cybersecurity threats and provides security hardening guidelines.

## 11.1. General Cybersecurity

**Description** Connecting a Universal Robots robot to a network can introduce cybersecurity risks. These risks can be mitigated by using qualified personnel and implementing specific measures for protecting the robot's cybersecurity. Implementing cybersecurity measures requires conducting a cybersecurity threat assessment. The purpose is to:

- Identify threats
- Define trust zones and conduits
- Specify the requirements of each component in the application



**WARNING**

Failure to conduct a cybersecurity risk assessment can place the robot at risk.

- The integrator or competent, qualified personnel shall conduct a cybersecurity risk assessment.



**NOTICE**

Only competent, qualified personnel shall be responsible for determining the need for specific cybersecurity measures and for providing the required cybersecurity measures.

## 11.2. Cybersecurity Requirements

**Description** Configuring your network and securing your robot requires you to implement the threat measures for cybersecurity. Follow all the requirements before you start configure your network, then verify the robot setup is secure.

**Cybersecurity**

- Operating personnel must have a thorough understanding of general cybersecurity principles and advanced technologies as used in the UR robot.
- Physical security measures must be implemented to allow only authorized personnel physical access to the robot.
- There must be adequate control of all access points. For example: locks on doors, badge systems, physical access control in general.



**WARNING**

Connecting the robot to a network that is not properly secured, can introduce security and safety risks.

- Only connect your robot to a trusted and properly secured network.

**Network configuration requirements**

- Only trusted devices are to be connected to the local network.
- There must be no inbound connections from adjacent networks to the robot.
- Outgoing connections from the robot are to be restricted to allow the smallest relevant set of specific ports, protocols and addresses.
- Only URCaps and magic scripts from trusted partners can be used, and only after verifying their authenticity and integrity

**Robot setup security requirements**

- Change the default password to a new, strong password.
- Disable the "Magic Files" when not actively used (PolyScope 5).
- Disable SSH access when not needed. Prefer key-based authentication over password-based authentication
- Set the robot firewall to the most restrictive usable settings and disable all unused interfaces and services, close ports and restrict IP addresses
-

## 11.3. Cybersecurity Hardening Guidelines

### Description

Although PolyScope includes many features for keeping the network connection secure, you can harden security by observing to following guidelines:

- Before connecting your robot to any network, always change the default password to a strong password.



#### NOTICE

You cannot retrieve or reset a forgotten or lost password.

- Store all passwords securely.

- Use the built-in settings to restrict the network access to the robot as much as possible.
- Some communication interfaces have no method of authenticating and encrypting communication. This is a security risk. Consider appropriate mitigating measures, based on your cybersecurity threat assessment.
- SSH tunneling (Local port forwarding) must be used to access robot interfaces from other devices if the connection crosses the trust zone boundary.
- Remove sensitive data from the robot before it is decommissioned. Pay particular attention to the URCaps and data in the program folder.
  - To ensure secure removal of highly sensitive data, securely wipe or destroy the SD card.

# 12. Communication Networks

---

## Fieldbus

You can use the Fieldbus options to define and configure the family of industrial computer network protocols used for real-time distributed control accepted by PolyScope:

- MODBUS
  - Ethernet/IP
  - PROFINET
  - PROFI-safe
  - UR Connect
-

# 12.1. MODBUS

## Description

Here, the MODBUS client (master) signals can be set up. Connections to MODBUS servers (or slaves) on specified IP addresses can be created with input/output signals (registers or digital). Each signal has a unique name so it can be used in programs.

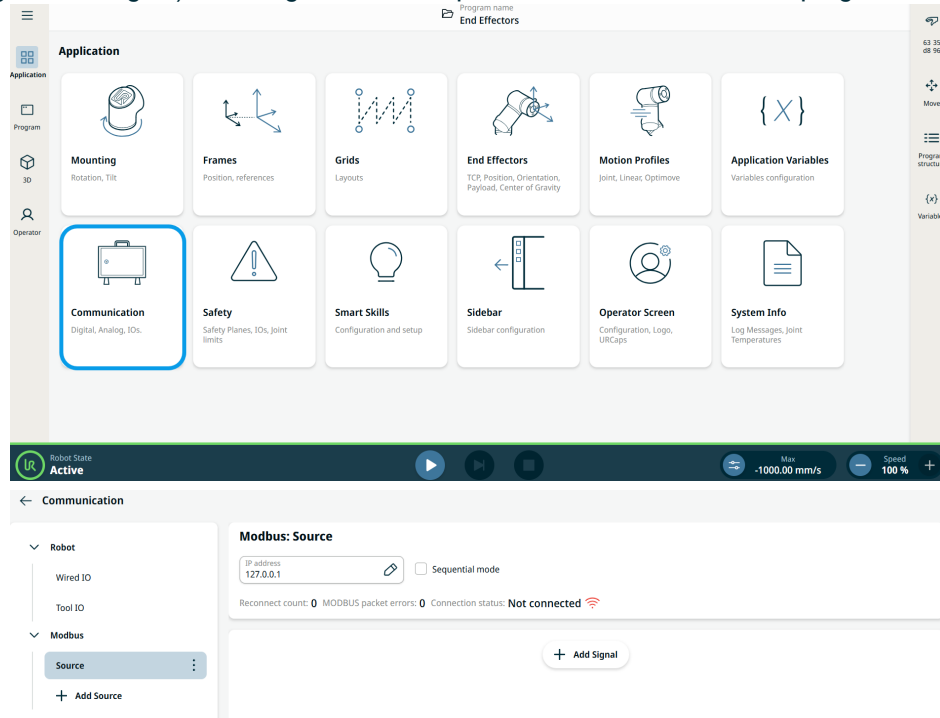

Copyright © 2009-2026 by Universal Robots A/S. All rights reserved.

**Add Signal** You may customized a signal name when adding a signal. Select the signal type, signal direction and specify frequency, timeout and other advanced settings. Signal could use single address or multiple addresses.

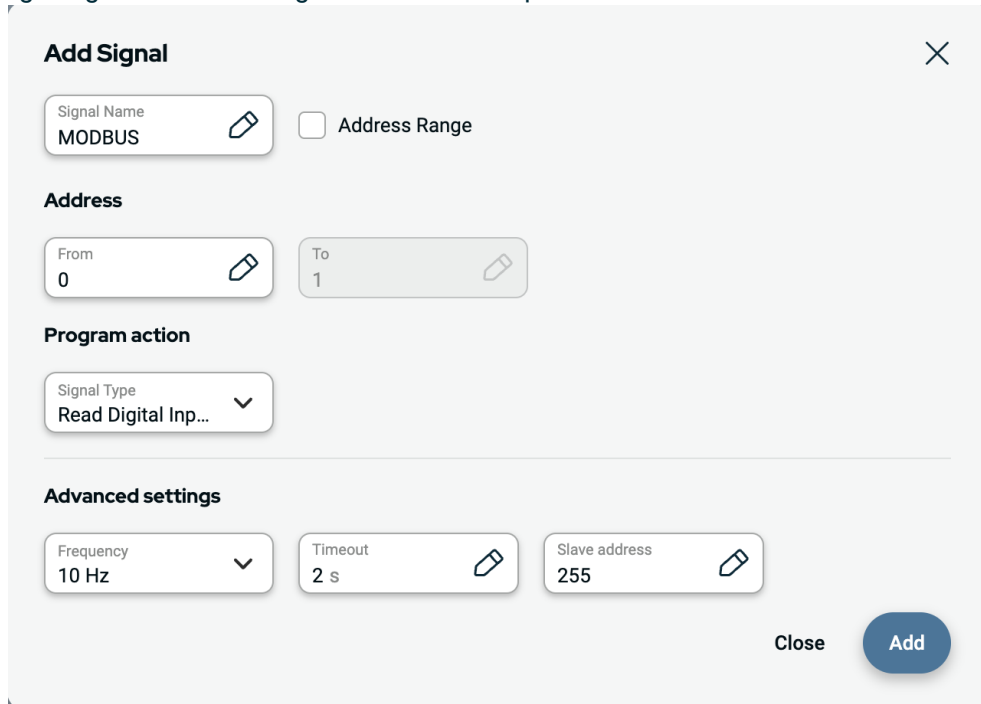

**Signal Source** Modbus signal source settings can be edited and deleted, Tap the **Config** button to edit, and tap the trashcan icon to delete.

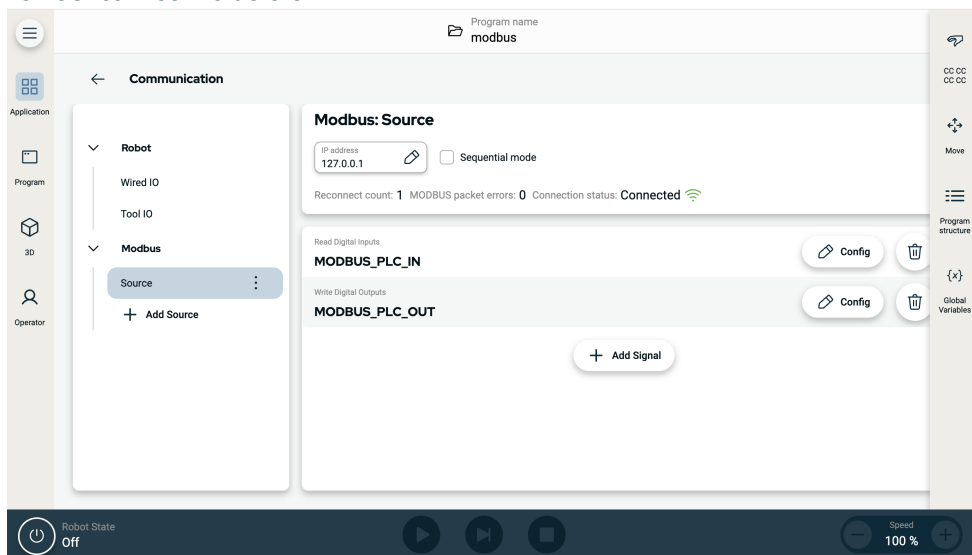

Copyright © 2009-2026 by Universal Robots A/S. All rights reserved.

**Programming**

Similar to other input signals, Modbus signals can be monitored. In the Program, on **Wait** command, select **Signal Input** under **Wait Type**. Then choose the Modbus source, the specific input signal, and the state to wait for. Address ranges can not be used in logical expressions. The program can use only single address, even if it is part of a range.

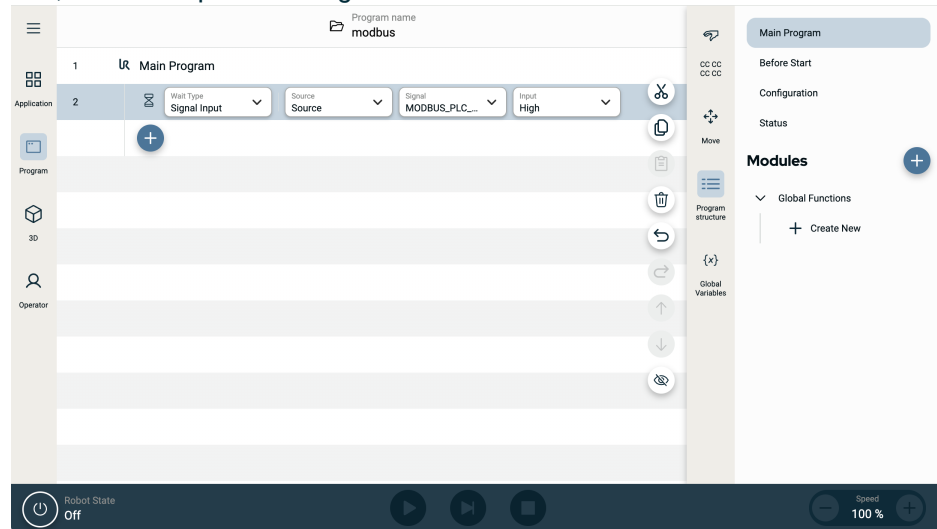

A Modbus output signal can be configured from **Set** command.

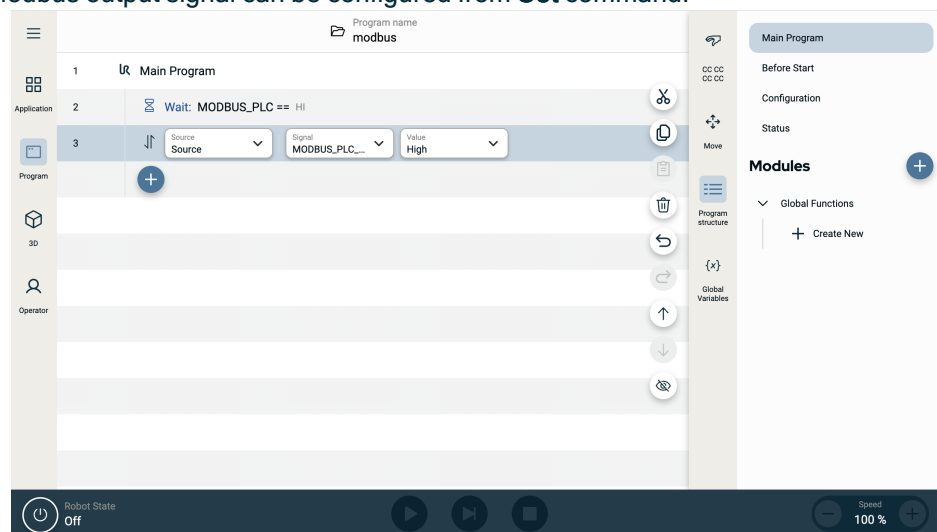

Copyright © 2009-2026 by Universal Robots A/S. All rights reserved.

## 12.2. Profinet

**Description**

The PROFINET network protocol enables or disables the connection of the robot to an industrial PROFINET IO-Controller. If the connection is enabled, you can select the action that occurs when a program loses PROFINET IO-Controller connection.

## Enable PROFINET

This is how you enable PROFINET function in PolyScope X.

1. In the top left of the screen, tap the Hamburger menu and then tap Settings.
2. In the menu on the left, under Security, tap Services.
3. Type the admin password.
4. Tap the PROFINET button to switch PROFINET on.

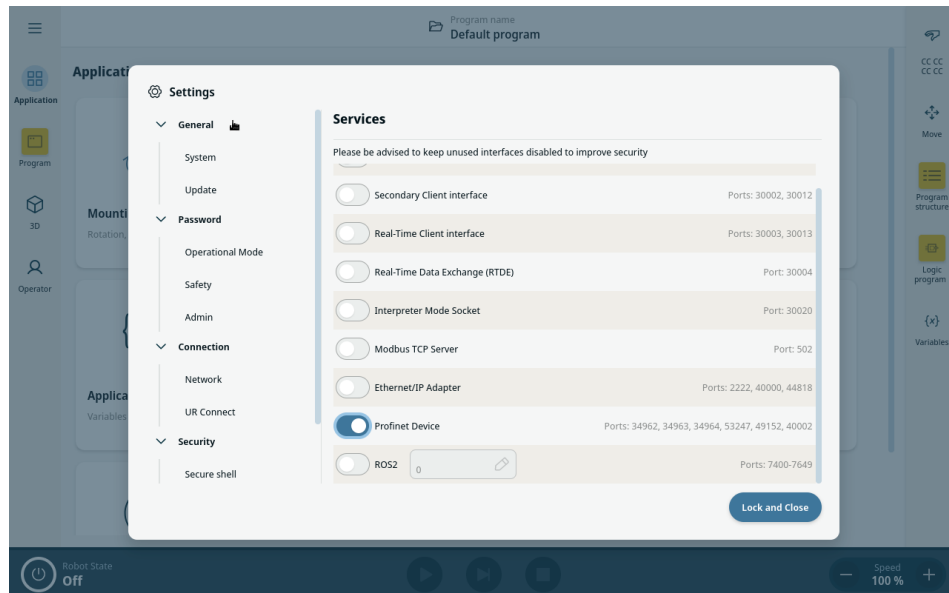

**Using PROFINET**

Find the PROFINET functions in PolyScope X:

In the PolyScope X Main Navigation.

1. Tap the Application icon.
2. Under Communication, select PROFINET from the left menu.

Select the relevant action from the list:

Ignore	PolyScope X ignores the loss of PROFINET connection, and the main program continues to run.
Pause	PolyScope X pauses the main program. The program resumes from where it stopped.
Stop	PolyScope X stops the main program.

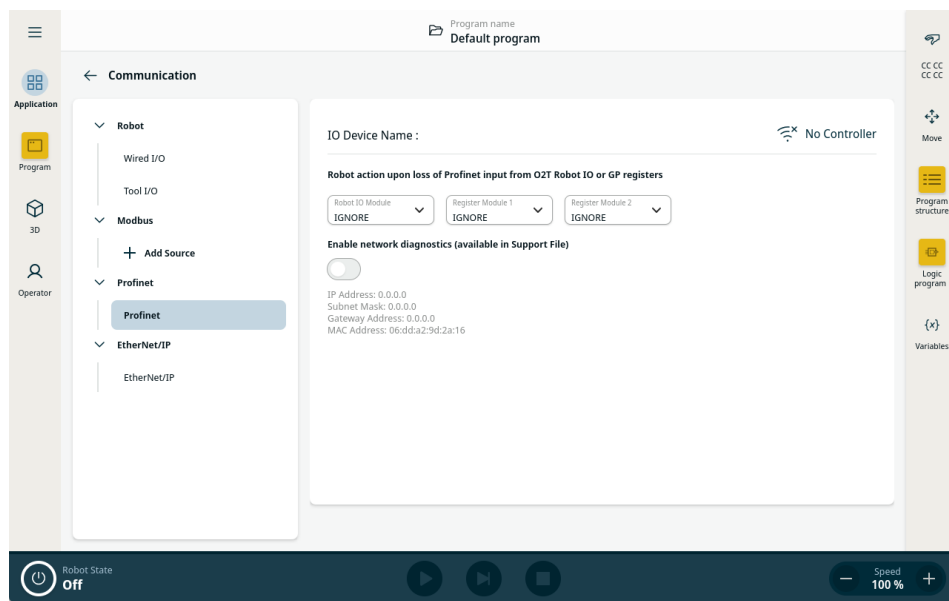

**Diagnostics**

Polyscope X has an option to record network traffic between Robot and PROFINET I/O-Controller. This can be used for diagnostics in case of connectivity issues.

- To enable this option, tap the button "Enable network diagnostics" to toggle on.

Communication data will be saved in a .pcap file.

The file is saved in Support File in System Manager. Up to 50 MB of data can be recorded in the diagnostics.

1. Go to the **Header**, and the **System Manager** appears.
2. Choose the program you are working on.
3. Tap the three-vertical-dots icon (kebab icon) and choose **Export**.

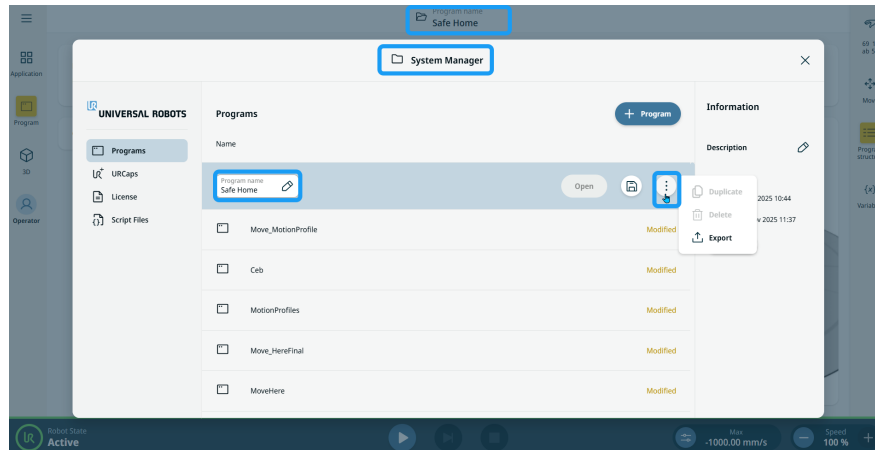

4. Choose the communication data in pcap file and Save.

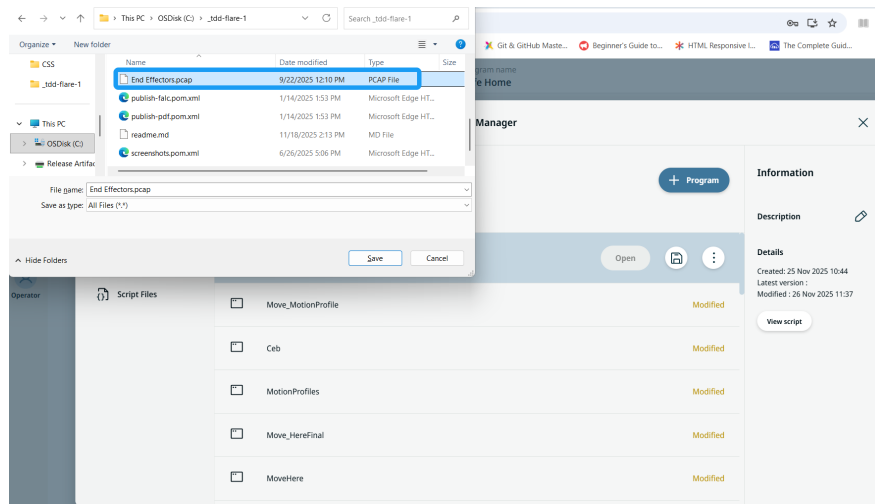

5. A pop-up notification appears in the main screen, stating you have successfully exported the file in the program.

**Ethernet port status**

When PROFINET Device is enabled, a new virtual ethernet port will be created. Virtual ethernet port configuration shows information about currently configured IP address, subnet mask, gateway and MAC address. Note that this virtual port is different from port configured in Robot network settings.

## 12.3. Ethernet/IP

### Description

EtherNet/IP is a network protocol that enables the connection of the robot to an industrial EtherNet/IP scanner device. If the connection is enabled, you can select the action that occurs when a program loses EtherNet/IP scanner device connection.

### Enable Ethernet/IP

This is how to enable Ethernet/IP function in PolyScope X.

1. In the top left of the screen, tap the Hamburger menu.
2. Tap Settings.
3. In the menu on the left, under Security, tap Services.
4. Type the admin password.
5. Tap the Ethernet/IP Adapter button to switch toggle on.

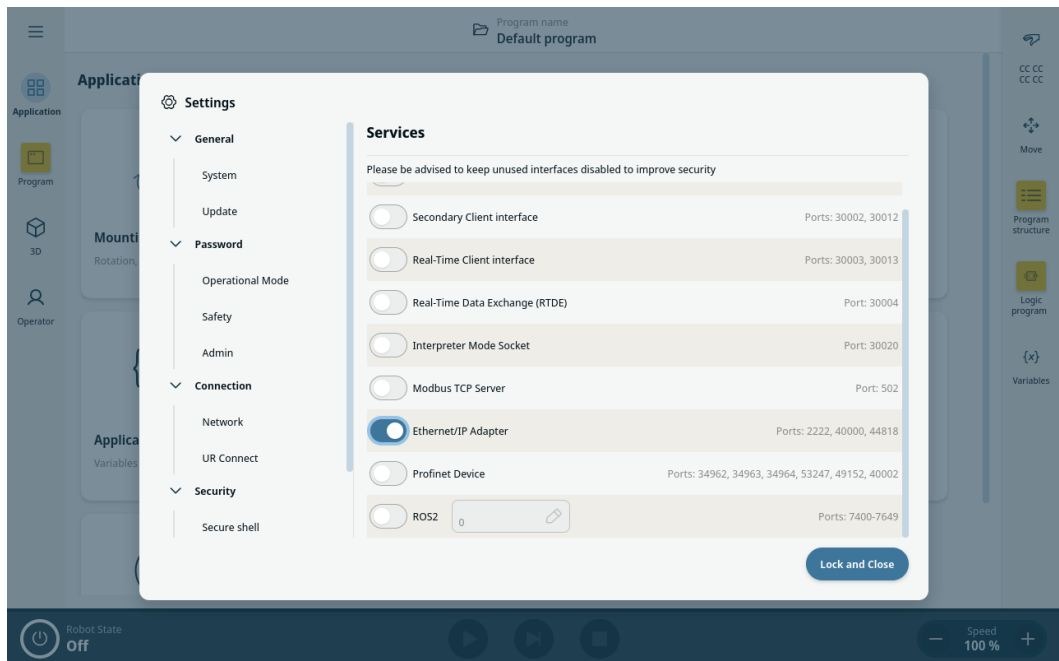

**Using Ethernet/IP**

This is how you find the Ethernet/IP functions in PolyScope X:

In the PolyScope X left header.

1. Tap the Application icon.
2. Under Communication, select Ethernet/IP from the left menu.

Select the relevant action from the list:

- Ignore** PolyScope X ignores the loss of EtherNet/IP connection, and the main program continues to run.
- Pause** PolyScope X pauses the main program. The program resumes from where it stopped.
- Stop** PolyScope X stops the main program.

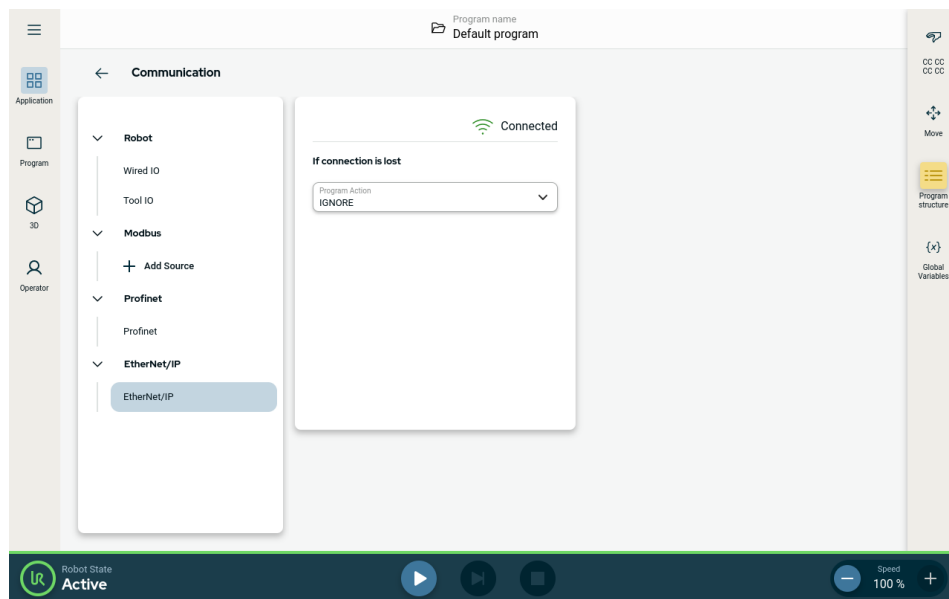

In the upper right corner of this screen, you can see the Ethernet/IP status.

- Connected** The robot is connected to the Ethernet/IP Scanner.
- No Scanner** Ethernet/IP Device is running, but no Scanner is connected to the robot via Ethernet/IP.
- Disabled** Ethernet/IP Device is not enabled.

Copyright © 2009-2026 by Universal Robots A/S. All rights reserved.

## 12.4. UR Connect

### Connect PolyScope X to myUR Cloud

You have to connect your PolyScope X software to the myUR Cloud service. You need to find you PIN code in your myUR account.

1. Go to Settings.
2. Go to UR Connect.
3. Hit the "Connect" button on the main UR Connect page.
4. Add you pin code from myUR.

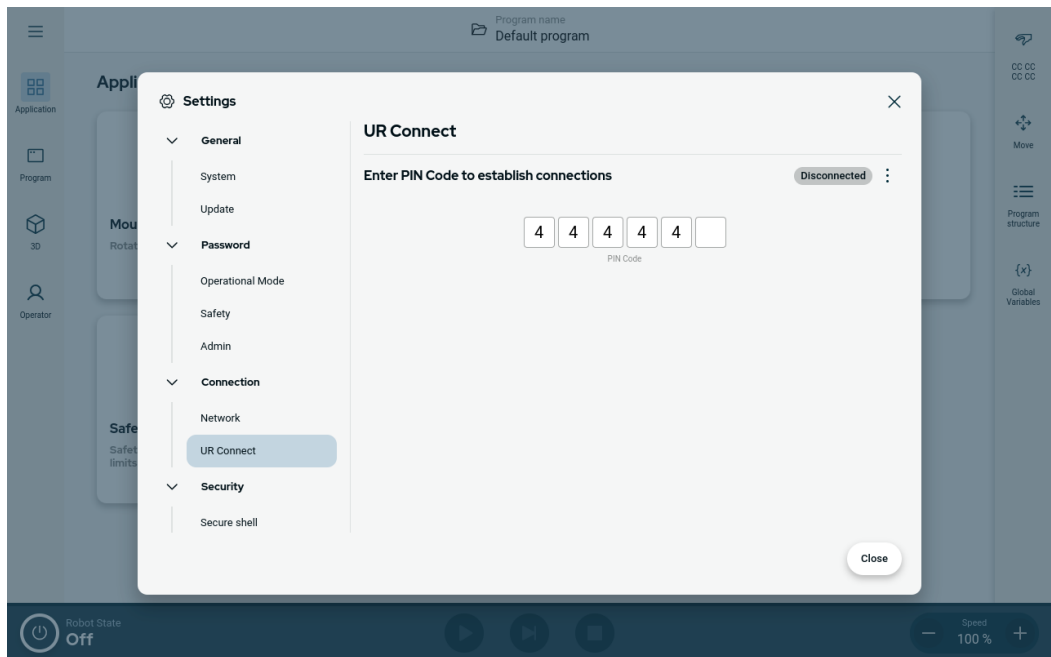

When you see the green icon in the right corner of the window, you are connected to the myUR Cloud.

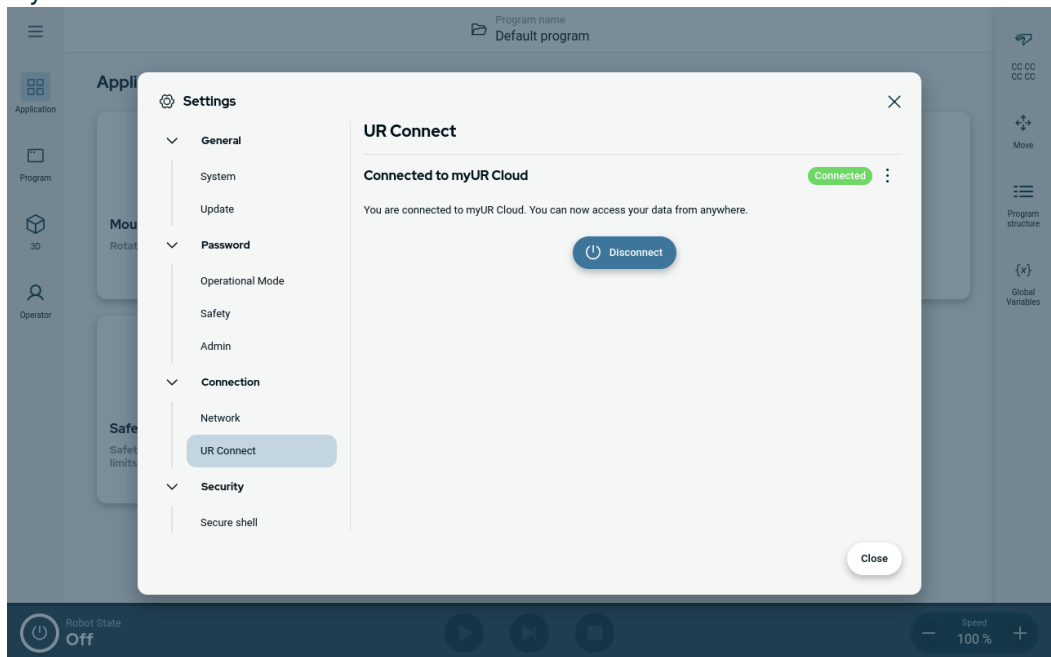

**Unsuccessful connect**

If you see the "Incorrect PIN code", please review your PIN code from myUR.

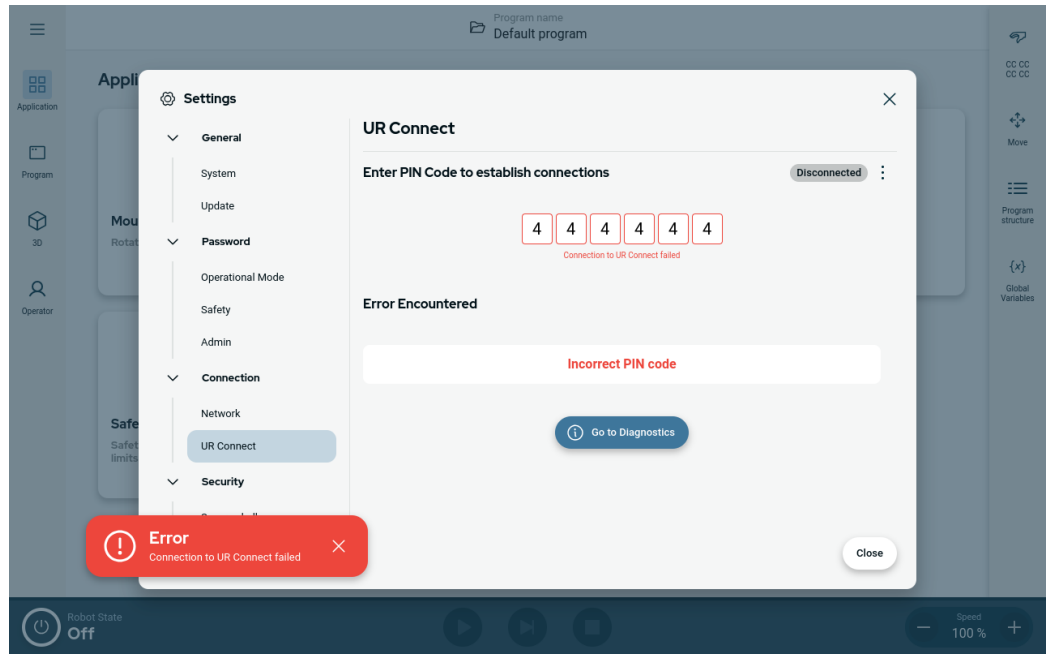

**Diagnostics**

If you experience any unexpected when the UR Connect is active, you can go to the Diagnostics.

1. Go to Settings.
2. Go to UR Connect.
3. Hit the kebab menu in the top right corner.
4. Select the "Diagnostics".

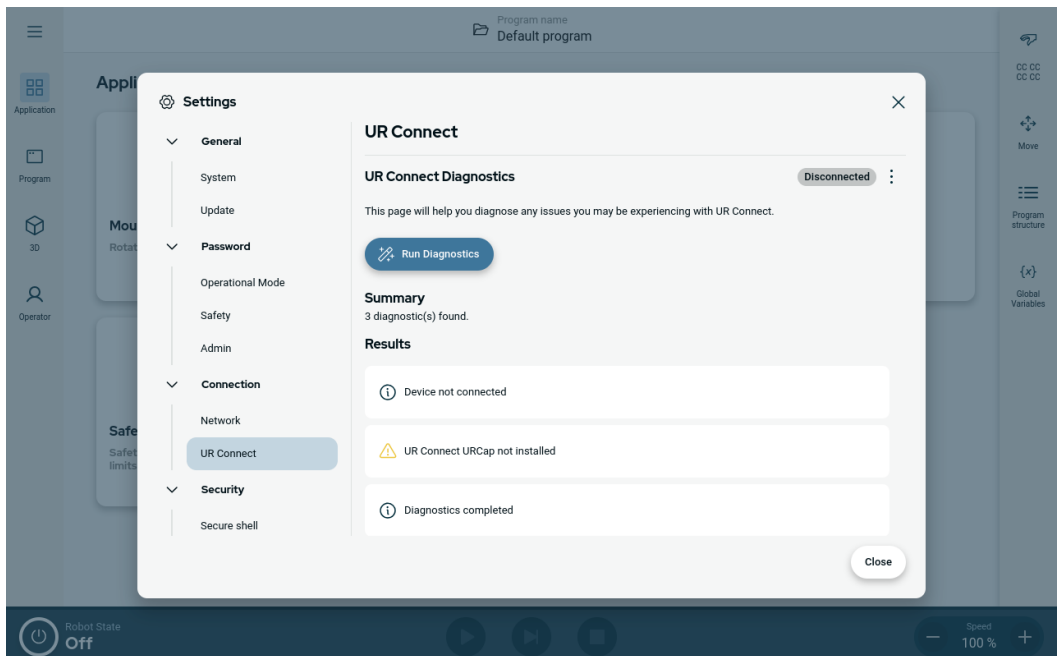
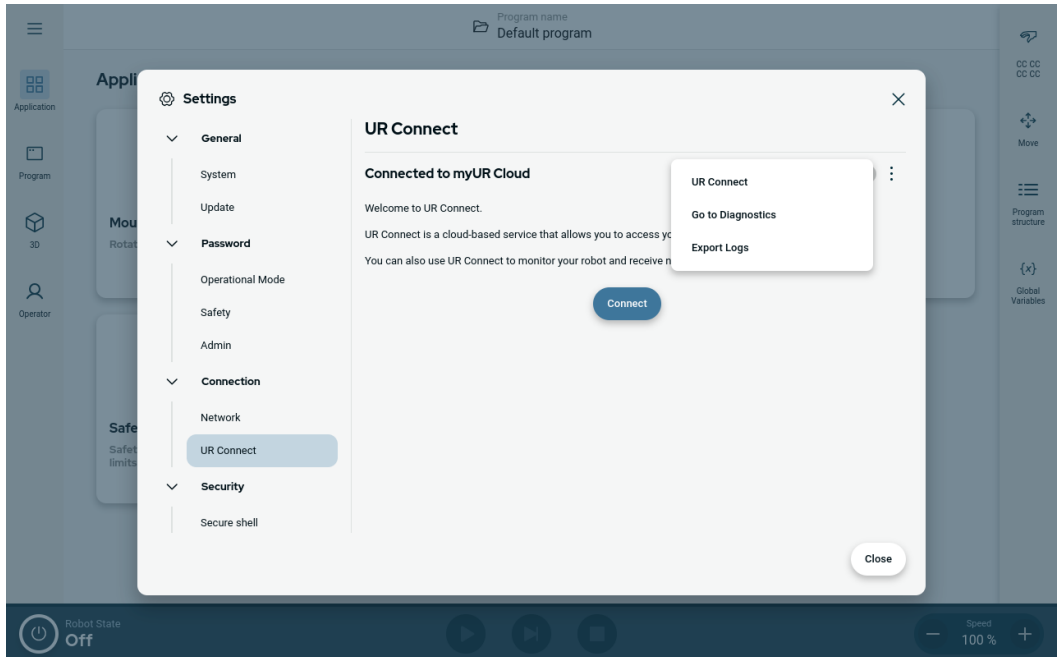

Copyright © 2009-2026 by Universal Robots A/S. All rights reserved.

**Export logs** It is possible to export the UR Connect logs from your PolyScope X software.

1. Go to Settings.
2. Go to UR Connect.
3. Hit the kebab menu in the top right corner.
4. Select the "Export Logs"
5. Select "Export to myUR" or "Export to USB".

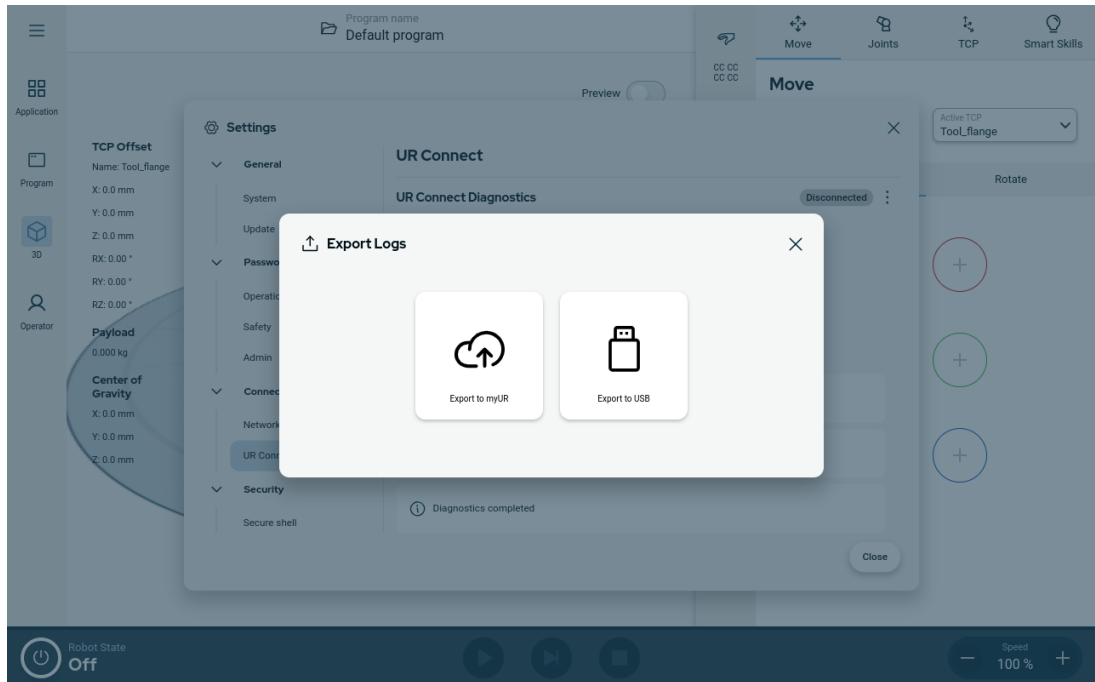

# 13. Risk Assessment

---

## Description

The risk assessment is a requirement that shall be performed for the application. The application risk assessment is the responsibility of the integrator. The user can also be the integrator.

The robot is partly completed machinery, as such the safety of the robot application depends on the tool/end effector, obstacles and other machines. The party performing the integration must use ISO 12100 and ISO 10218-2 to conduct the risk assessment. Technical Specification ISO/TS 15066 can provide additional guidance for collaborative applications. The risk assessment shall consider all tasks throughout the lifetime of the robot application, including but not limited to:

- Teaching the robot during set-up and development of the robot application
- Troubleshooting and maintenance
- Normal operation of the robot application

A risk assessment must be conducted **before** the robot application is powered on for the first time. The risk assessment is an iterative process. After physically installing the robot, verify the connections, then complete the integration. A part of the risk assessment is to determine the safety configuration settings, as well as the need for additional emergency stops and/or other protective measures required for the specific robot application.

---

### Safety configuration settings

Identifying the correct safety configuration settings is a particularly important part of developing robot applications. Unauthorized access to the safety configuration must be prevented by enabling and setting password protection.



#### WARNING

Failure to set password protection can result in injury or death due to purposeful or inadvertent changes to configuration settings.

- Always set password protection.
- Set up a program for managing passwords, so that access is only by persons who understand the effect of changes.

Some safety functions are purposely designed for collaborative robot applications. These are configurable through the safety configuration settings. They are used to address risks identified in the application risk assessment.

The following limit the robot and as such can affect the energy transfer to a person by the robot arm, end effector and workpiece.

- **Force and power limiting:** Used to reduce clamping forces and pressures exerted by the robot in the direction of movement in case of collisions between the robot and the operator.
- **Momentum limiting:** Used to reduce high transient energy and impact forces in case of collisions between robot and operator by reducing the speed of the robot.
- **Speed limitation:** Used to ensure the speed is less than the configured limit.

The following orientation settings are used to avoid movements and reduce exposure of sharp edges and protrusions to a person.

- **Joint, elbow and tool/end effector position limiting:** Used to reduce risks associated with certain body parts: Avoid movement towards head and neck.
- **Tool/end effector orientation limiting:** Used to reduce risks associated with certain areas and features of the tool/end effector and work-piece: Avoid sharp edges being pointed towards the operator, by turning the sharp edges inward towards the robot.

### Stopping performance risks

Some safety functions are purposely designed for any robot application. These features are configurable through the safety configuration settings. They are used to address risks associated with the stopping performance of the robot application.

The following limit the robot stopping time and stopping distance to ensure stopping will occur before reaching the configured limits. Both settings automatically affect the speed of the robot to ensure the limit is not exceeded.

- **Stopping Time Limit:** Used to limit the stopping time of the robot.
- **Stopping Distance Limit:** Used to limit the stopping distance of the robot.

If either of the above is used, there is no need for manually performed periodic stopping performance testing. The robot safety control does continuous monitoring.

If the robot is installed in a robot application where hazards cannot be reasonably eliminated or risks cannot be sufficiently reduced by use of the built-in safety-related functions (e.g. when using a hazardous tool/end effector, or hazardous process), then safeguarding is required.



**WARNING**

Failure to conduct a application risk assessment can increase risks.

- Always conduct an application risk assessment for foreseeable risks and reasonably foreseeable misuse.

For collaborative applications, the risk assessment includes the foreseeable risks due to collisions and to reasonably foreseeable misuse.

The risk assessment shall address:

- Severity of harm
- Likelihood of occurrence
- Possibility to avoid the hazardous situation

**Potential hazards**

Universal Robots identifies the potential significant hazards listed below for consideration by the integrator. Other significant hazards can be associated with a specific robot application.

- Penetration of skin by sharp edges and sharp points on tool/end effector or tool/end effector connector.
- Penetration of skin by sharp edges and sharp points on nearby obstacles.
- Bruising due to contact.
- Sprain or bone fracture due to impact.
- Consequences due to loose bolts that hold the robot arm or tool/end effector.
- Items falling out of, or flying from the tool/end effector, e.g. due to a poor grip or power interruption.
- Mistaken understanding of what is controlled by multiple emergency stop buttons.
- Incorrect setting of the safety configuration parameters.
- Incorrect settings due to unauthorized changes to the safety configuration parameters.

## 13.1. Pinch Hazard

**Description** You can avoid pinching hazards by removing obstacles in these areas, by placing the robot differently, or by using a combination of safety planes and joint limits to eliminate the hazards by preventing the robot moving into this area of its workspace.



### CAUTION

Placing the robot in certain areas can create pinching hazards that can lead to injury.

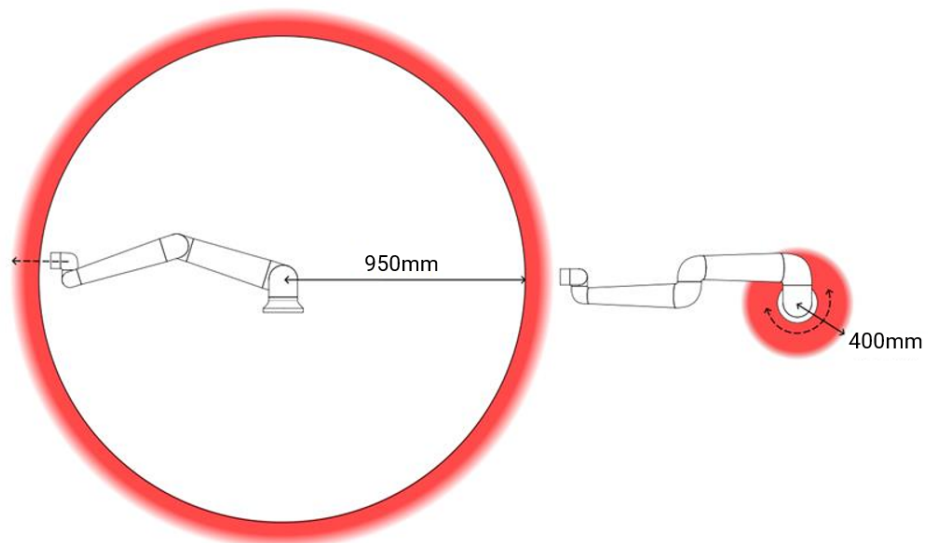

*Due to the physical properties of the robot arm, certain workspace areas require attention regarding pinching hazards. One area (left) is defined for radial motions when the wrist 1 joint is at least 950 mm from the base of the robot. The other area (right) is within 400 mm of the base of the robot, when moving tangentially.*

## 13.2. Stopping Time and Stopping Distance

---

**Description** The graphical data provided for **Joint 0 (base)**, **Joint 1 (shoulder)** and **Joint 2 (elbow)** is valid for stopping distance and stopping time:

- Category 0
- Category 1
- Category 2

The **Joint 0** test was carried out using a horizontal movement, where the rotational axis was perpendicular to the ground. During the **Joint 1** and **Joint 2** tests, the robot followed a vertical trajectory, where the rotational axes were parallel to the ground, and the stop was done while the robot was moving downward.

The Y-axis is the distance from where the stop is initiated to the final position.



**NOTICE**

You can set user-defined safety rated maximum stopping times and distances. If user-defined settings are used, the program speed is dynamically adjusted to always comply with the selected limits.



**NOTICE**

Some of the plots below may not reach 100% speed for high extensions and payloads. This occurs because the robot's inbuilt safety compliance functions dynamically reduce the robot speed to ensure safe operation in these high-load cases.

**Joint 0 (BASE)**

Stopping distance in meters for 33% of 18 kg.

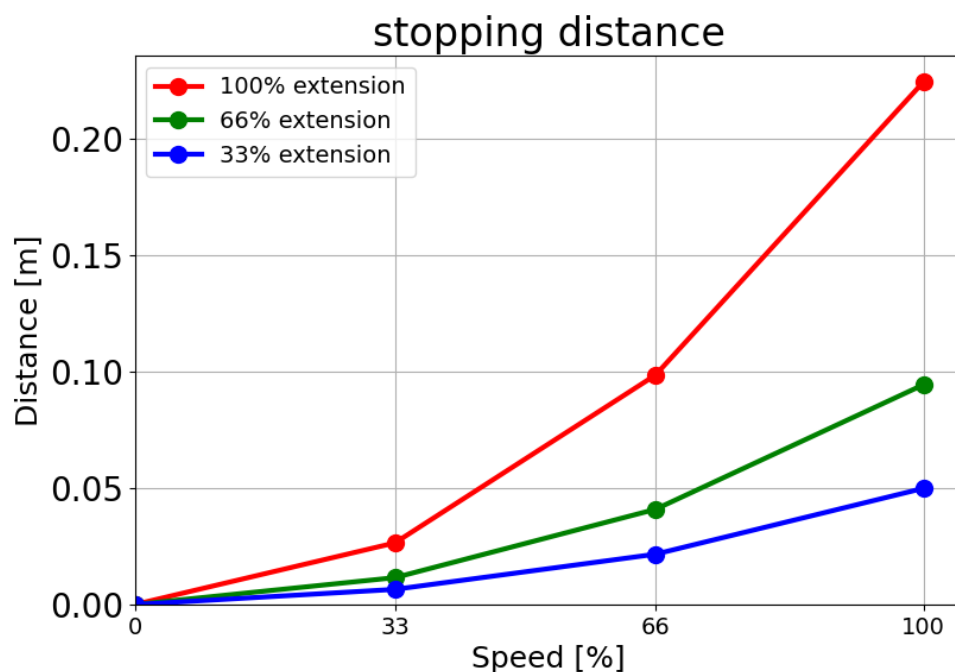

Stopping distance in meters for 66% of 18 kg.

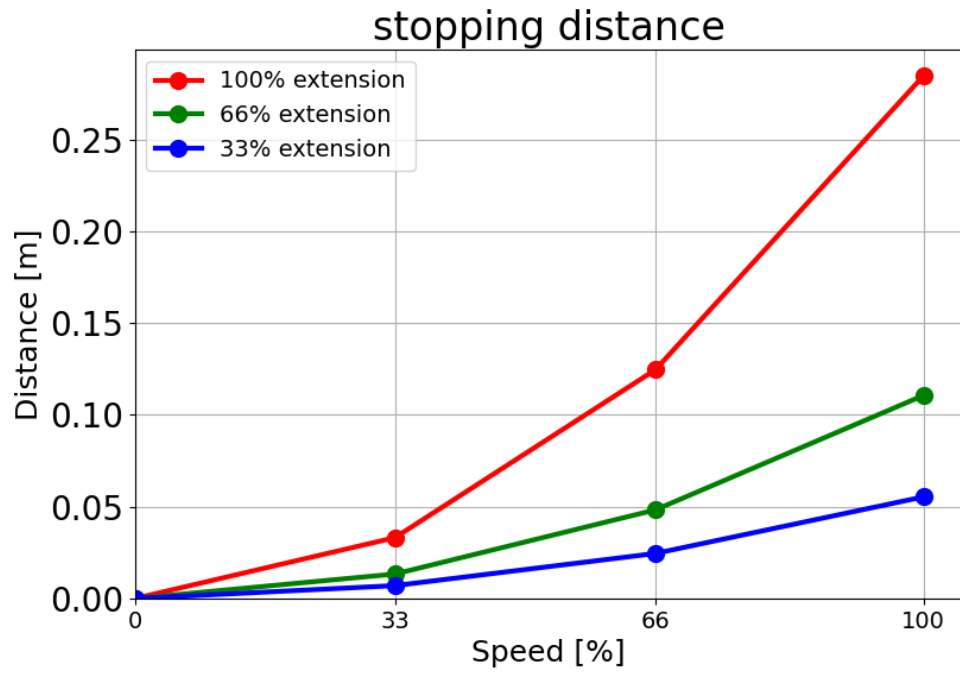

Stopping distance in meters for maximum payload of 18 kg

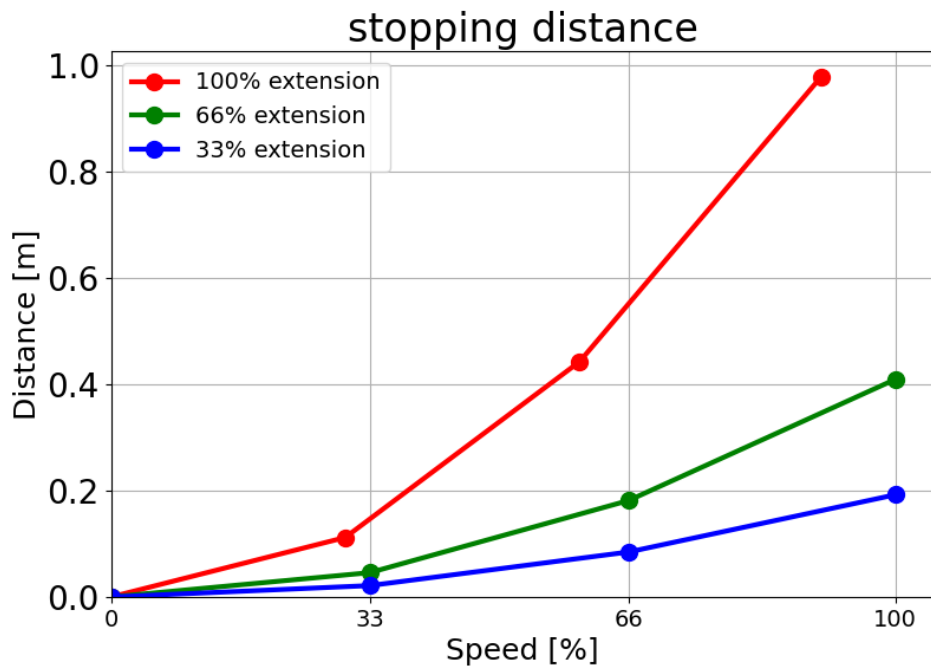

Copyright © 2009-2026 by Universal Robots A/S. All rights reserved.

**Joint 0  
(BASE)**

Stopping time  
in seconds for  
33% of 18 kg.

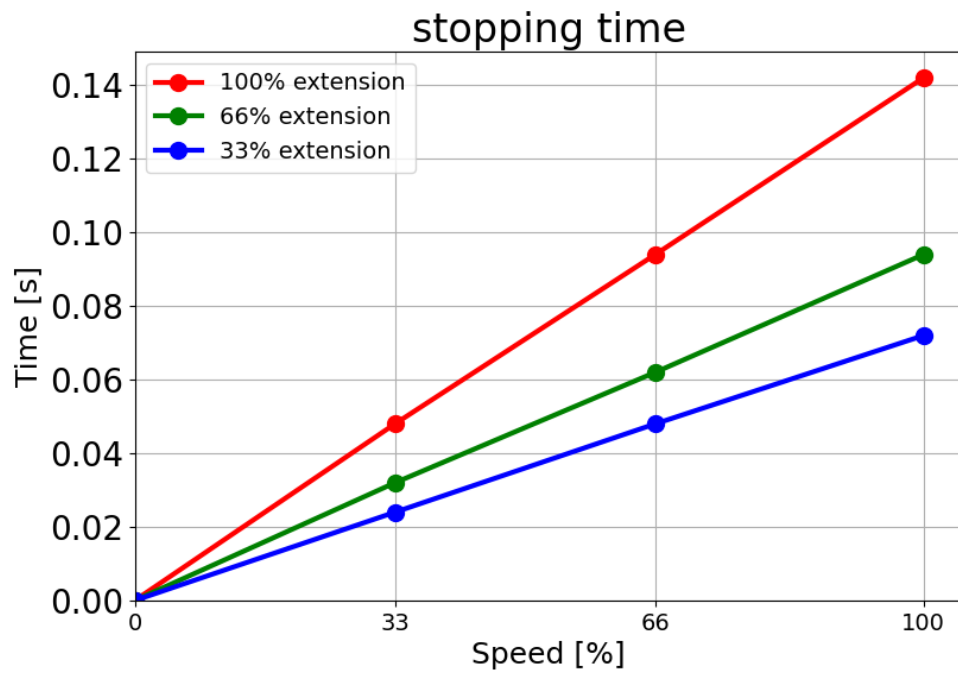

Stopping time  
in seconds for  
66% of 18 kg.

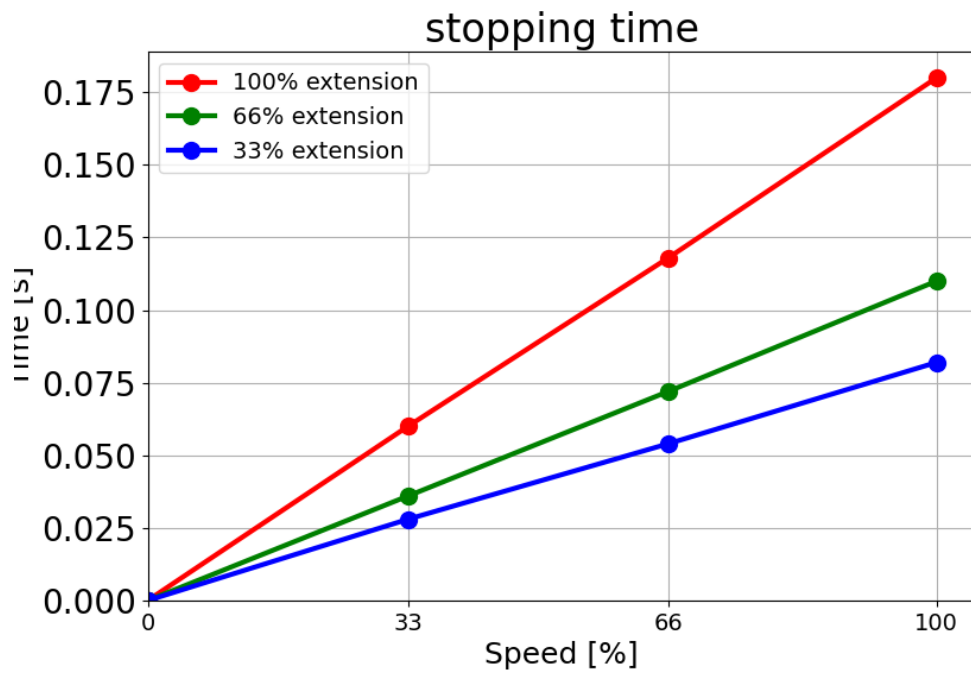

Stopping time in seconds for maximum payload of 18 kg.

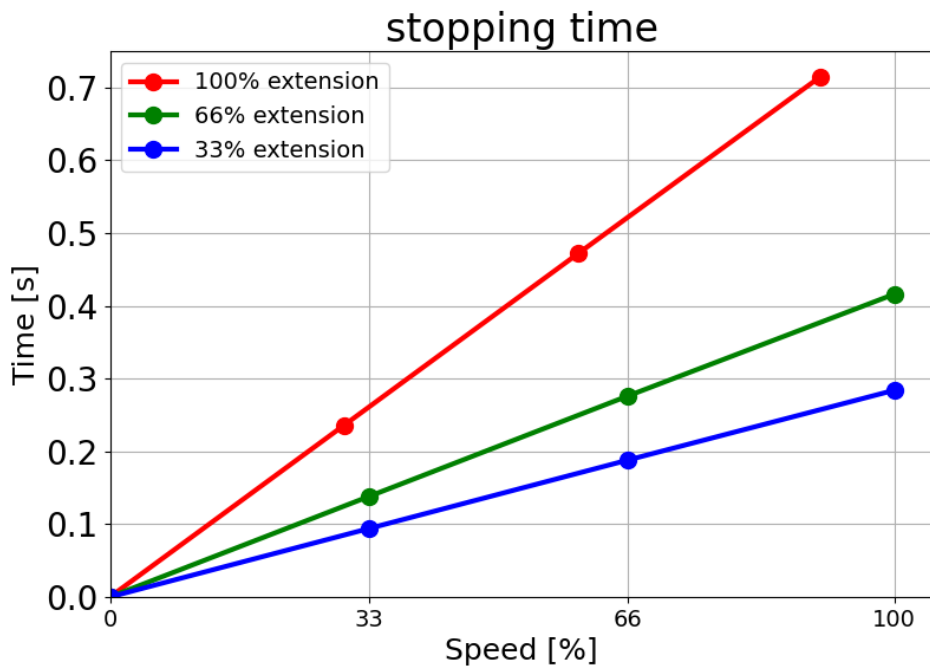

**Joint 1 (SHOULDER)**

Stopping distance in meters for 33% of 18 kg.

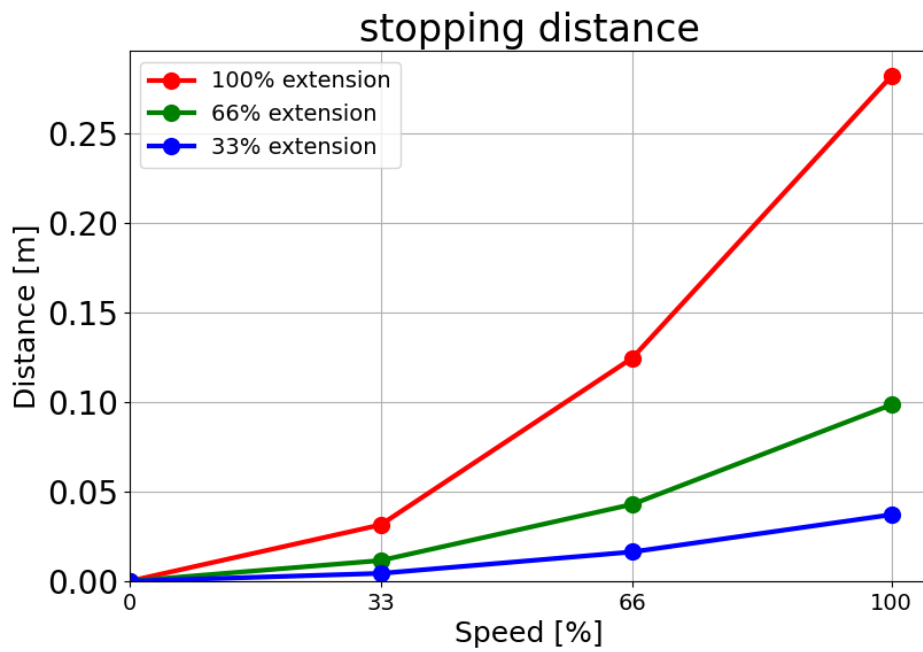

Copyright © 2009-2026 by Universal Robots A/S. All rights reserved.

Stopping distance in meters for 66% of 18 kg

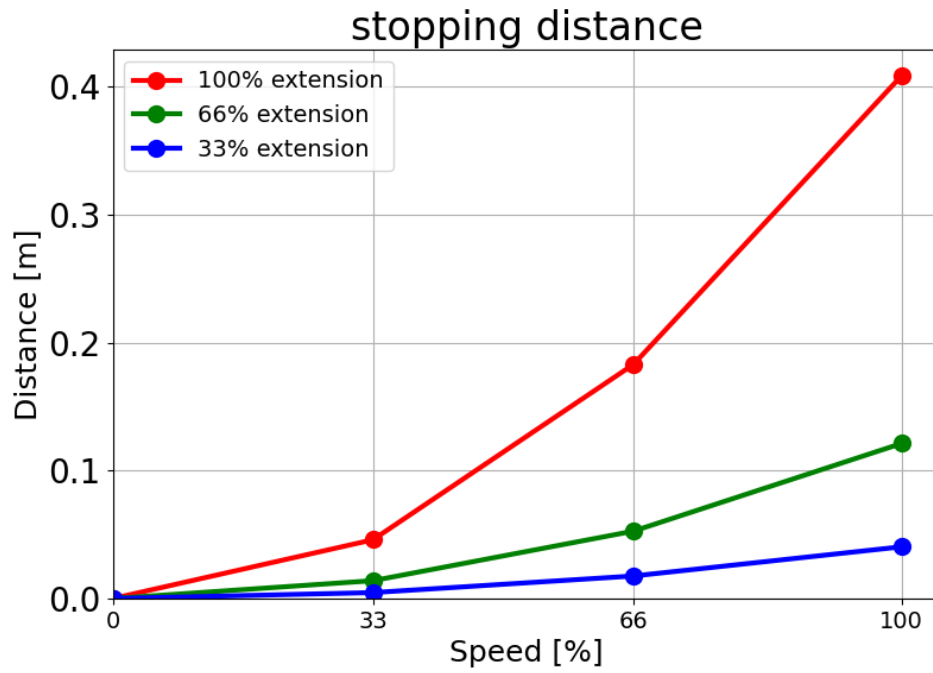

Stopping distance in meters for maximum payload of 18 kg

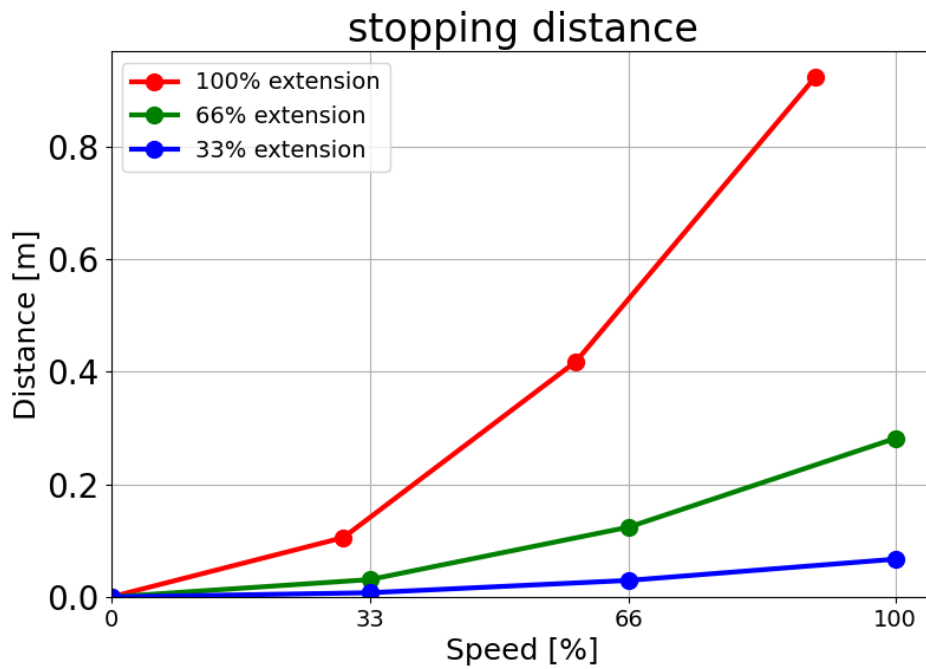

**Joint 1  
(SHOULDER)**

Stopping time in seconds for 33% of 18 kg

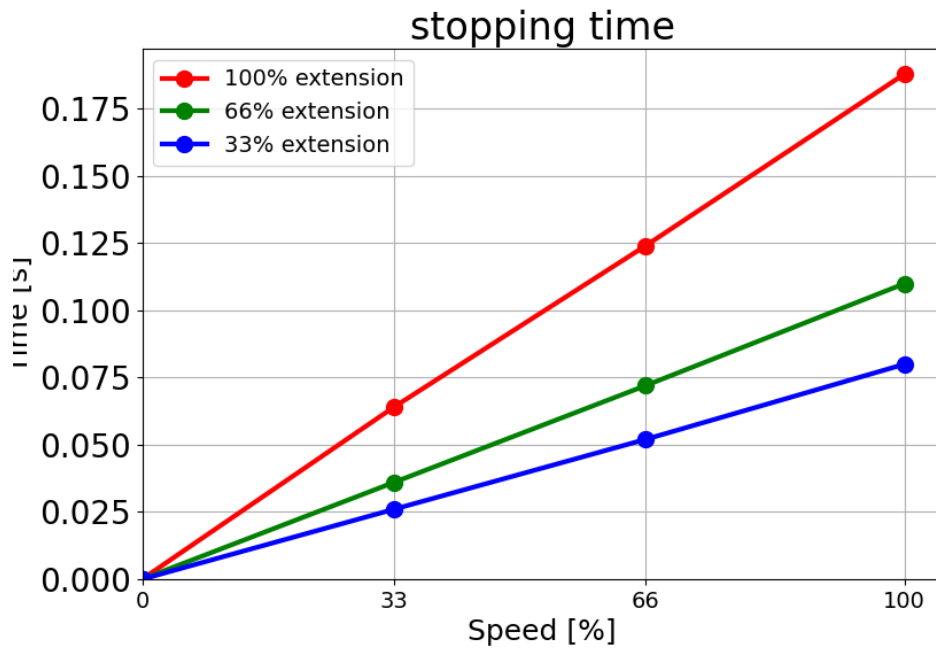

Stopping time in seconds for 66% of 18 kg

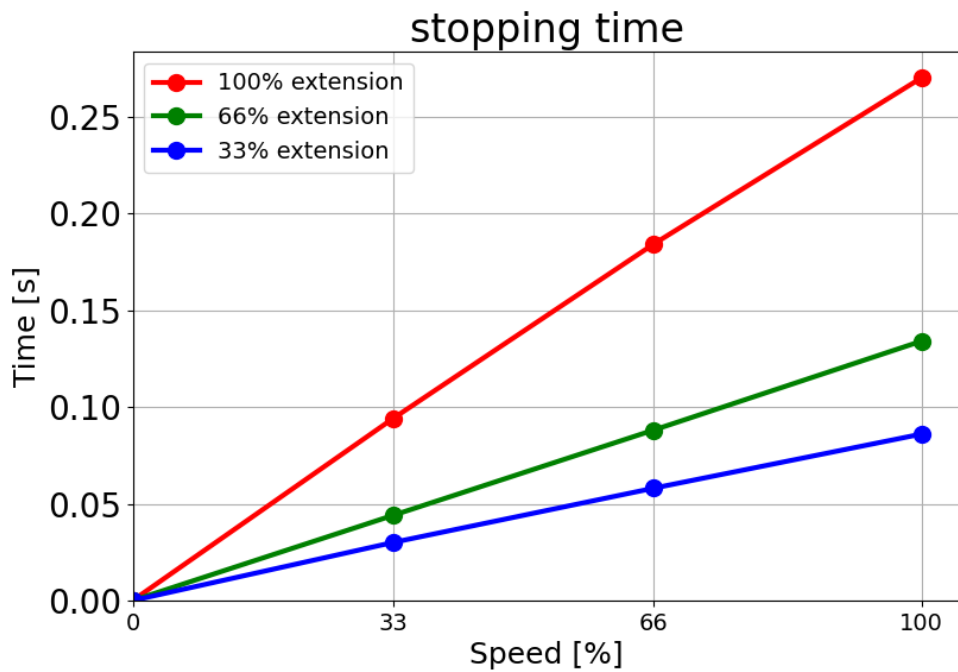

Copyright © 2009-2026 by Universal Robots A/S. All rights reserved.

Stopping time in seconds for maximum payload of 18 kg.

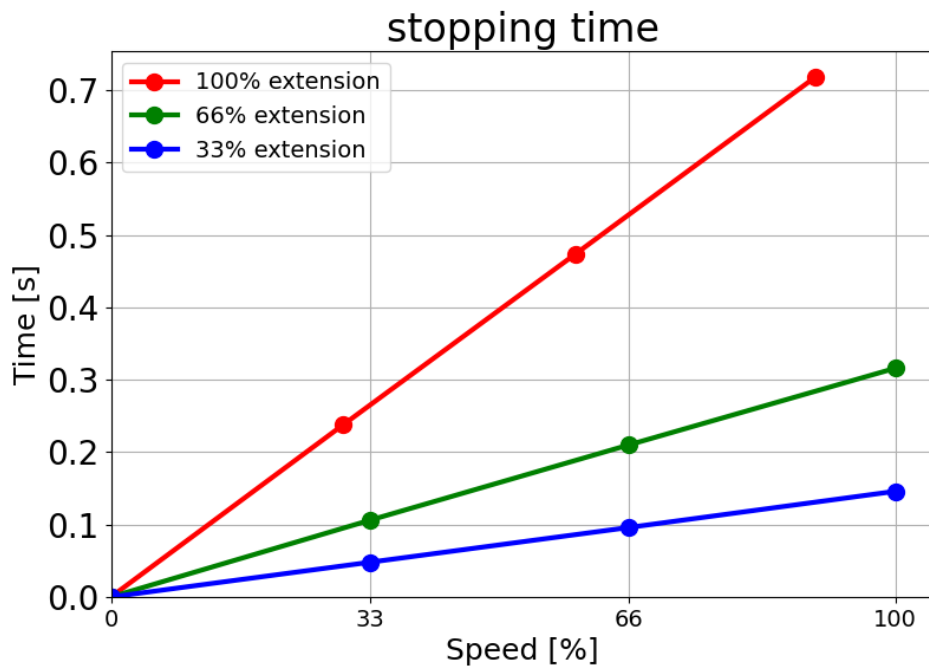

#### Joint 2 (ELBOW)

Stopping distance in meters for 33% of 18 kg.

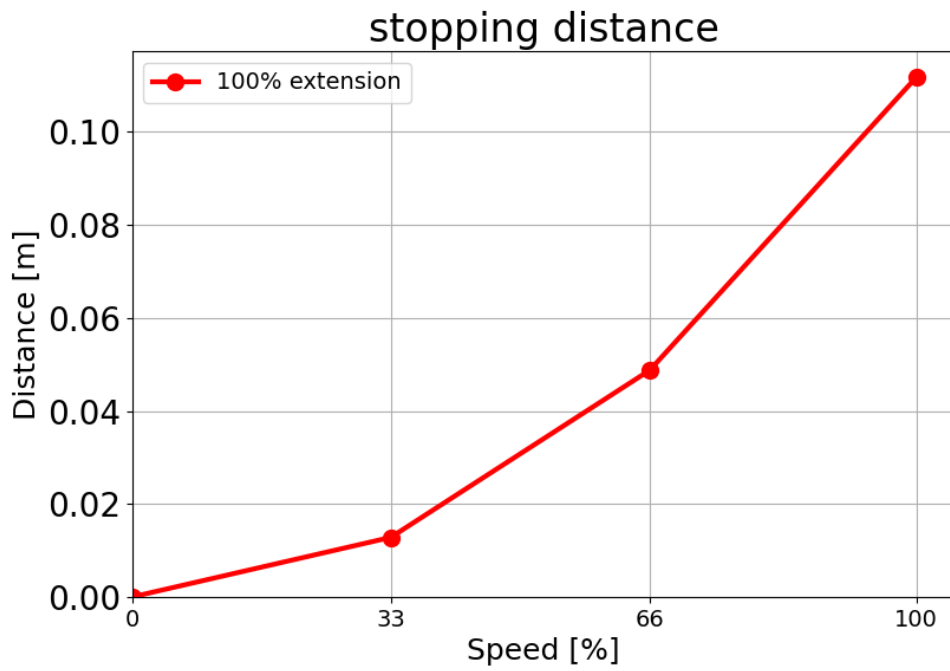

Stopping distance in meters for 66% of 18 kg

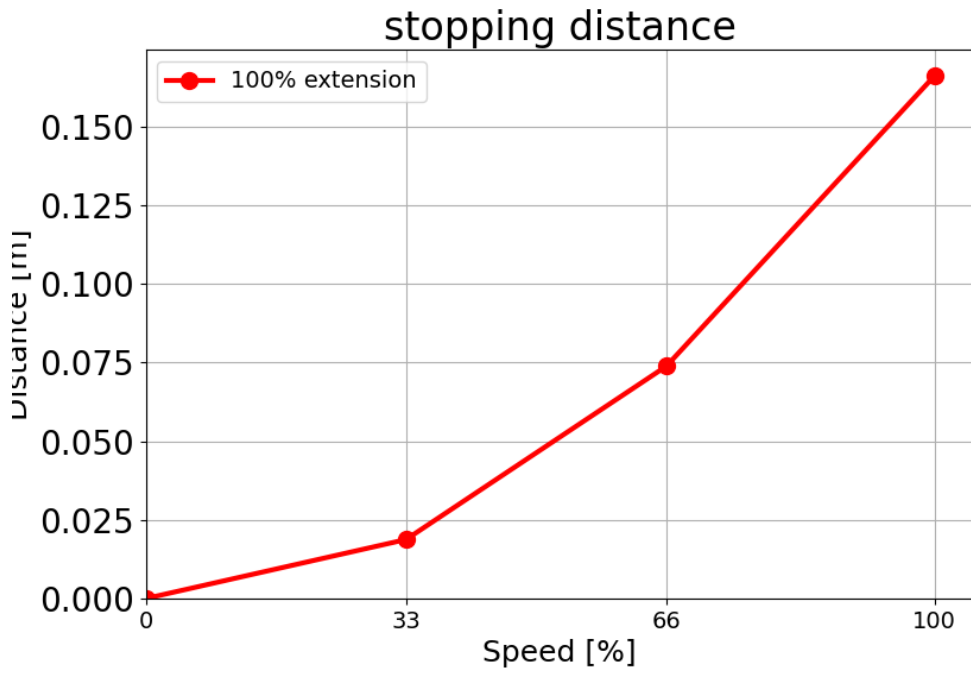

Stopping distance in meters for maximum payload of 18 kg

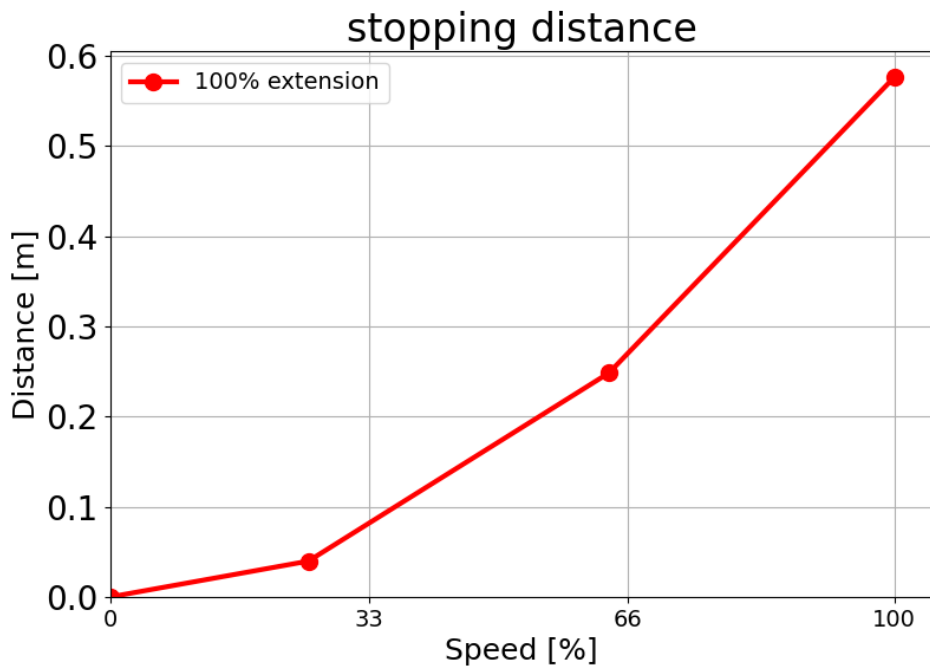

Copyright © 2009-2026 by Universal Robots A/S. All rights reserved.

**Joint 2  
(ELBOW)**

Stopping time  
in seconds for  
33% of 18 kg

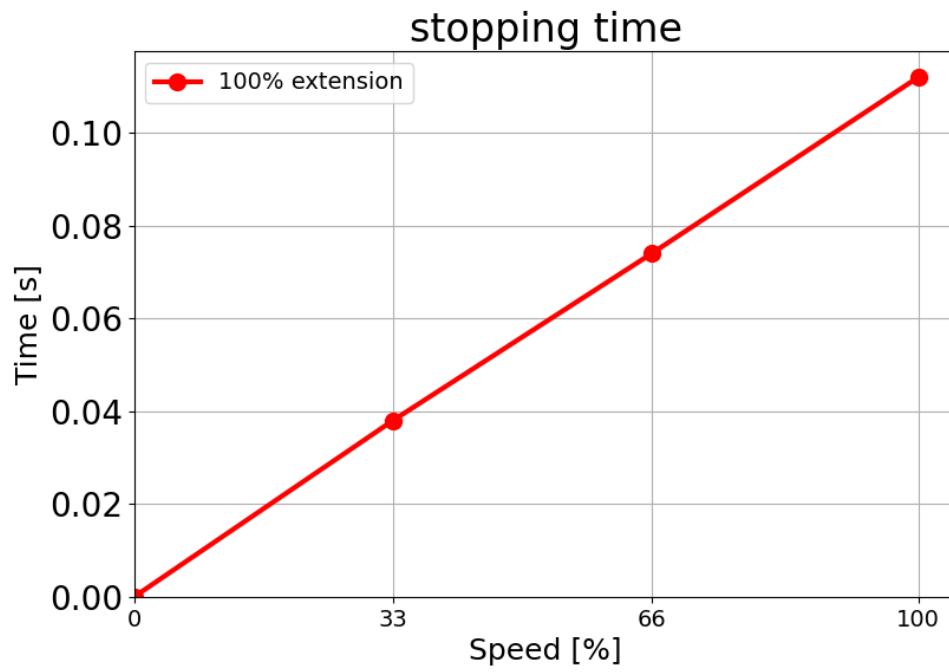

Stopping time  
in seconds for  
66% of 18 kg

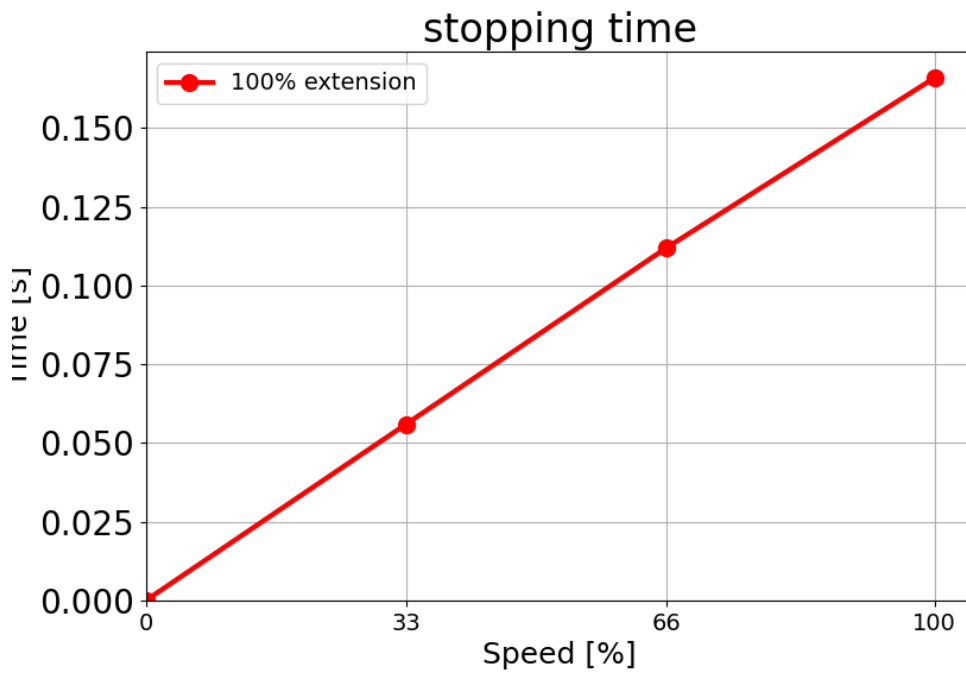

Stopping time in seconds for maximum payload of 18 kg

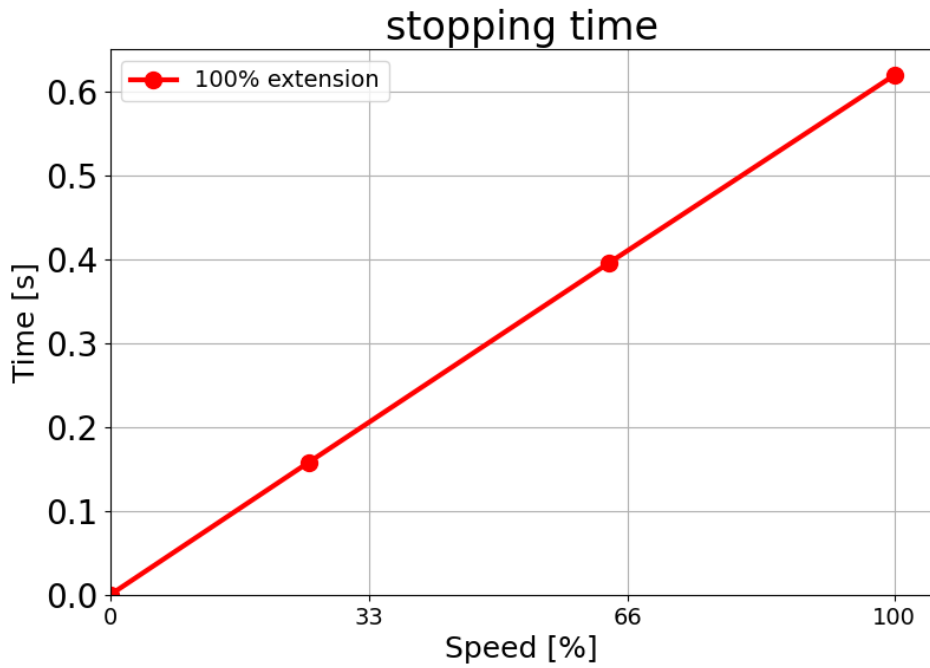

### 13.3. Stop Categories

**Description**

Depending on the circumstances, the robot can initiate three types of stop categories defined according to IEC 60204-1. These categories are defined in the following table.

Stop Category	Description
0	Stop the robot by immediate removal of power.
1	Stop the robot in an orderly, controlled manner. Power is removed once the robot is stopped.
2	*Stop the robot with power available to the drives, while maintaining the trajectory. Drive power is maintained after the robot is stopped.

\*Universal Robots robots' Category 2 stops are further described as SS1 or as SS2 type stops according to IEC 61800-5-2.

# 14. Emergency Events

---

**Description** Follow the instructions here to handle emergency situations, such as activating the emergency stop using the red push-button. This section also describes how to manually move the system without power.

---

## 14.1. Emergency Stop

---

**Description** The Emergency Stop or E-stop is the red push-button located on the Teach Pendant. Press the emergency stop push-button to stop all robot motion. Activating the emergency stop push-button causes a stop category one (IEC 60204-1). Emergency stops are not safeguards (ISO 12100).

Emergency stops are complementary protective measures that do not prevent injury. The risk assessment of the robot application determines if additional emergency stop push-buttons are required. The emergency stop function and the actuating device must comply with ISO 13850.

After an emergency stop is actuated, the push-button latches in that setting. As such, each time an emergency stop is activated, it must be manually reset at the push-button that initiated the stop.

Before resetting the emergency stop push-button, you must visually identify and assess the reason the E-stop was first activated. Visual assessment of all the equipment in the application is required. Once the problem is solved, reset the emergency stop push-button.

### To reset the emergency stop push-button

1. Hold the push-button and twist clockwise until the latching disengages.  
You should feel when the latching is disengaged, indicating the push-button is reset.
  2. Verify the situation and whether to reset the emergency stop.
  3. After resetting the emergency stop, restore power to the robot and resume operation.
-

## 14.2. Movement Without Drive Power

---

### Description

In the event of an emergency, when powering the robot is either impossible or unwanted, you can use forced back-driving to move the robot arm.

Forced back-driving requires you to push, or pull, the robot arm hard to move the joint. Bigger robot arms can involve more than one person to move the joint.

Each joint brake has a friction clutch that enables movement during high forced torque. Forced back-driving requires high force and one or more people may be required to move the robot.

In clamping situations, two or more people are required to do the forced back-driving. In some situations, two or more people are required to disassemble the robot arm.

Personnel using the UR robot are to be trained to respond to emergency events. Supplemental information shall be provided, on integration.



#### WARNING

Risks due to an unsupported robot arm breaking or falling can cause injury or death.

- Do not disassemble the robot during an emergency event.
- Support the robot arm before removing power.



#### NOTICE

Moving the robot arm manually is intended for emergency and service purposes only. Unnecessary moving of the robot arm can lead to property damage.

- Do not move the joint more than 160 degrees, to ensure the robot can find its original physical position.
- Do not move any joint more than necessary.

## 14.3. Clamp Connection: Disassembly

### Description



#### WARNING

Unsupported joints can fall or be dropped and cause injury.

- Support joints while clamps are being removed.



#### NOTICE

Failure to support the joint/s while clamps are removed can result in damage to equipment.

- Prevent joints from falling while you remove the clamps by doing any of the following:
  - Use something to support underneath the part that is coming off.
  - Disassemble the joint while it is laying down.
  - Support with lifting equipment.

If you do not test the old joint before you replace it, you can damage property or equipment.

Always perform a joint verification test before you replace a joint. See the Joint Verification section in the Service Manual for more information.

**To  
Disassembl  
e**

1. Attach the ESD wristband from the spare part package or tool kit to an electrically grounded surface.
2. Remove the black flat-ring.  
You can use pointy tweezers or a small flat-head screwdriver.

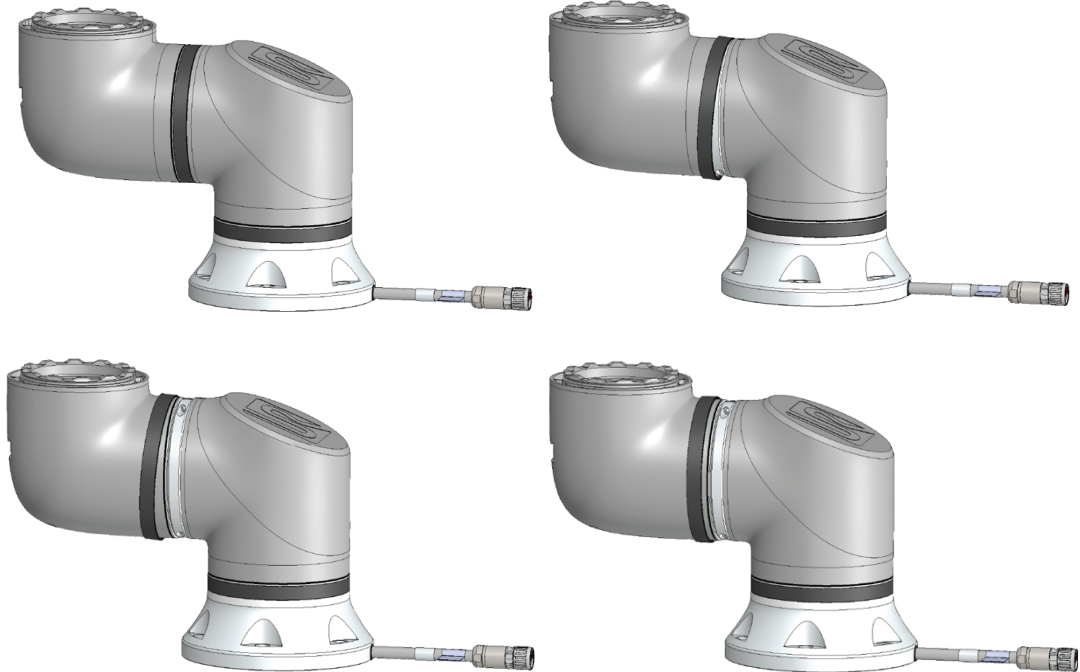

3. Remove the screws and the clamp on one side.

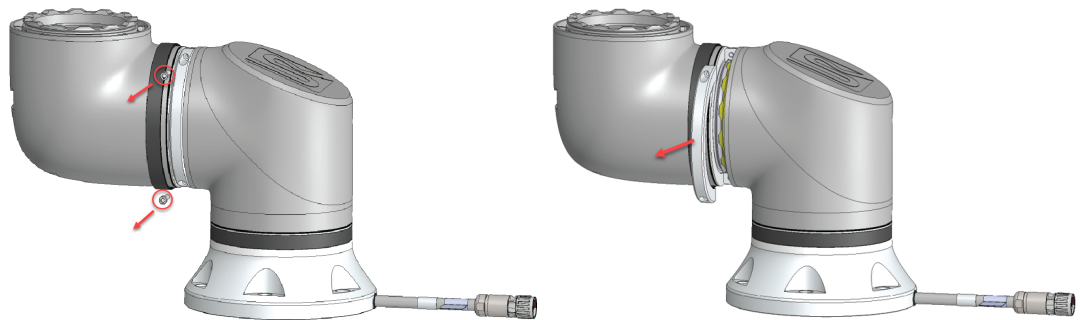

4. Support the joint as you remove the second side of the clamp.

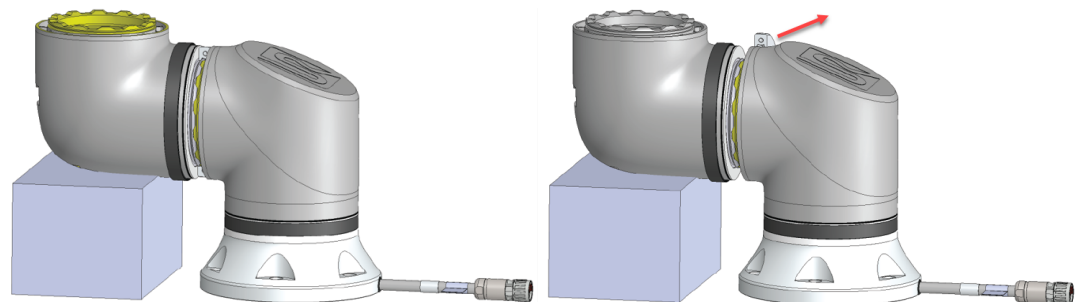

5. The joint is now loose and you can remove it.

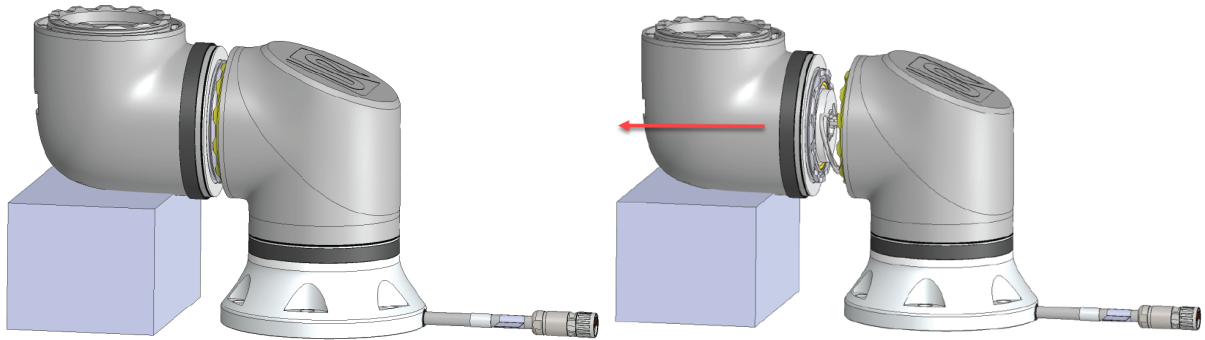

6. Gently unplug the connector from the PCB on the joint.

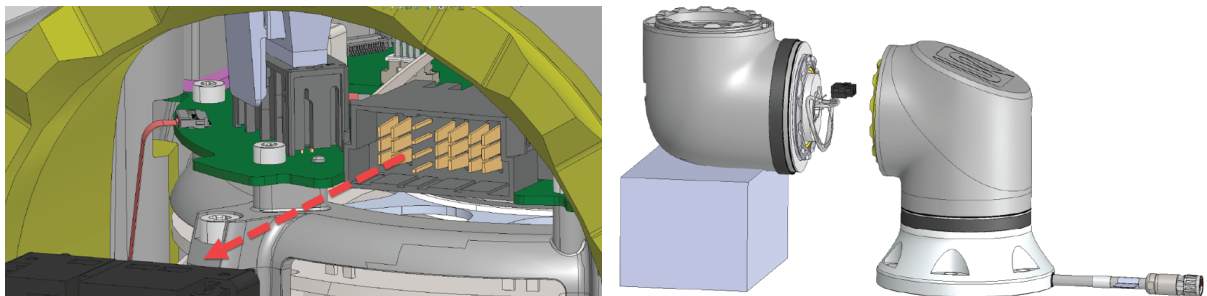

7. The joint is now dismantled.

## 14.4. Operational Mode

**Description** You access and activate different modes using Teach Pendant or the Dashboard Server. If an external mode selector is integrated, it control the modes - not PolyScope or the Dashboard Server.

**Automatic Mode** When this mode is activated the robot can only execute a program of pre-defined tasks. You cannot modify or save programs and installations.

**Manual Mode** When this mode is activated you can program the robot. You can modify and save programs and installations. The speeds used in Manual Mode must be limited to prevent injury. When the robot is operating in Manual Mode, a person could be positioned within reach of the robot. The speed must be limited to the value that is appropriate for the application risk assessment.



**WARNING**

Injury can occur if the speed used, while the robot is operating in Manual Mode, is too high.

**Recovery Mode** This mode activates when a safety limit from the active limit set is violated, the robot arm performs a Stop Category 0. If an active safety limit, such as a joint position limit or a safety boundary, is violated already when the robot arm is powered on, it starts up in Recovery mode. This makes it possible to move the robot arm back within the safety limits. In Recovery mode, the movement of the robot arm is restricted by a fixed limit that you cannot customize.

**High Speed Manual Mode** When this mode is enabled, you can temporarily exceed the default speed limit of the tool and the elbow.

The robot performs a Safeguard Stop in Manual mode, if a Three-Position Enabling Device is configured, and either released (not pressed) or it is fully compressed.

Switching between Automatic mode to Manual mode requires the Three-Position Enabling Device to be fully released and pressed again to allow the robot to move. When using High Speed Manual Mode, use safety joint limits or safety planes to restrict the robot's moving space.



**NOTICE**

After five minutes of inactivity the speed limit resets to the default.

**To enable High Speed Manual**

1. Tap **Application** and select **Safety**.
2. Access the **Three Position** options.
3. On the page, slide the button **Allow manual high speed**.

**Mode switching**

Operational mode	Manual	Automatic
Move robot with +/- on Move Tab	x	
Freedrive	x	
Execute Programs	Reduced speed*	x
Edit & save program	x	

\*If a Three-Position Enabling device is configured, the robot operates at Manual Reduced Speed unless High Speed Manual Mode is enabled.

**WARNING**

- Any suspended safeguards must be returned to full functionality before selecting Automatic Mode.
- Wherever possible, Manual Mode shall only be used with all persons located outside the safeguarded space.
- If an external mode selector is used, it must be placed outside the safeguarded space.
- No-one is to enter, or be within, the safeguarded space in Automatic Mode, unless safeguarding is used or the collaborative application is validated for power and force limiting (PFL).

**Three-Position Enabling Device**

When a Three-Position Enabling Device is used and the robot is in Manual Mode, movement requires pressing the Three-Position Enabling Device to the center-on position. The Three-Position Enabling Device has no effect in Automatic Mode.

**NOTICE**

- Some UR robot sizes might not be equipped with a Three-Position Enabling Device. If the risk assessment requires the enabling device, a 3PE Teach Pendant must be used.

A 3PE Teach Pendant (3PE TP) is recommended for programming. If another person can be within the safeguarded space when in Manual Mode, an additional device can be integrated and configured for the additional person's use.

**Switching Modes**

To switch between modes, in the Right Header, select the profile icon to display the Mode Selection.

- Automatic indicates the operational mode of the robot is set to Automatic.
- Manual indicates the operational mode of the robot is set to Manual.

PolyScope X is automatically in Manual Mode when the Safety I/O configuration with Three-Position Enabling Device is enabled.

**Select Remote Mode**

It is only possible to change the remote mode, when you have changed the operational mode to "Automatic".  
If you change remote mode from "remote" to "local" the operational mode will go back to "manual".

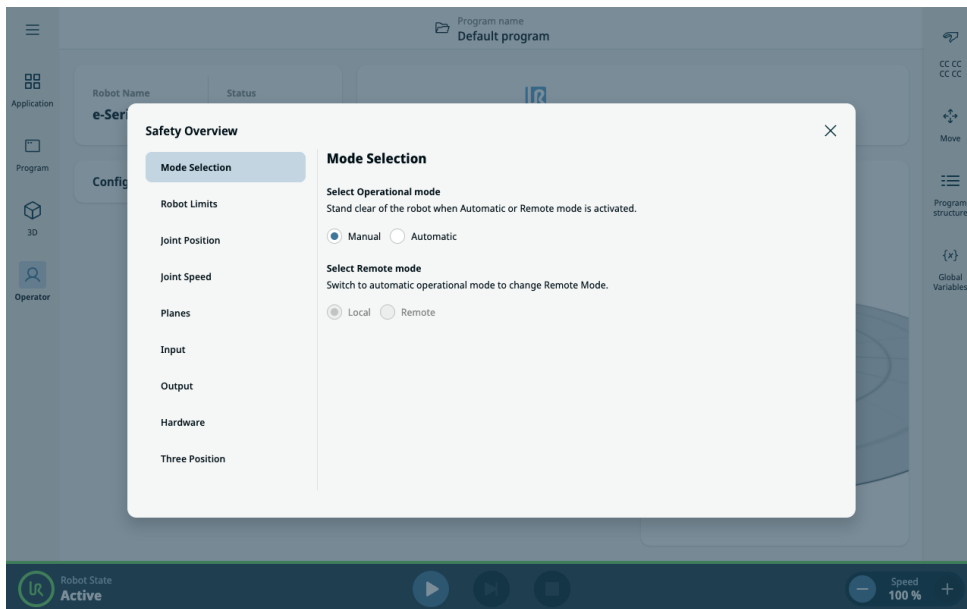

# 15. Transportation

**Description** Only transport the robot in its original packaging. Save the packaging material in a dry place if you want to move the robot later.  
 When moving the robot from its packaging to the installation space, hold both tubes of the robot arm at the same time. Hold the robot in place until all mounting bolts are securely tightened at the base of the robot.  
 Lift the Control Box by its handle.



## WARNING

Incorrect lifting techniques, or using improper lifting equipment, can lead to injury.

- Avoid overloading your back or other body parts when lifting the equipment.
- Use proper lifting equipment.
- All regional and national lifting guidelines shall be followed.
- Make sure to mount the robot according to the instructions in Mechanical Interface.



## NOTICE

If the robot is attached to 3rd third-party application/ installation during transport, please refer to the following:

- Transporting the robot without its original packaging will void all warranties provided by Universal Robots A/S.
- If the robot is transported as part of a prefabricated solution, securely mounted, and in full compliance with the recommendations outlined below, it is not considered a breach of warranty.

**Disclaimer** Universal Robots cannot be held responsible for any damage caused by transportation of the equipment.  
 See the recommendations for transportation without packaging at: [universal-robots.com/manuals](https://universal-robots.com/manuals)

## 15.1. Transportation Without Packaging

**Description** Universal Robots always recommends transporting the robot in its original packaging. These recommendations are written to reduce unwanted vibrations in joints and brake systems and reduce joint rotation. If the robot is transported without its original packaging, then please refer to the following guidelines:

- Fold the robot as much as possible - do not transport the robot in the singularity position.
- Move the center of gravity in the robot as close to the base as possible.
- Secure each tube to a solid surface on two different points on the tube.
- Secure any attached end effector rigidly in 3 axes.

### Transport

Fold the robot as much as possible.

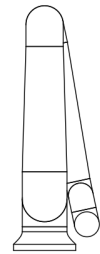
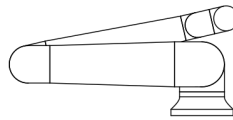

Do not transport extended. (singularity position)

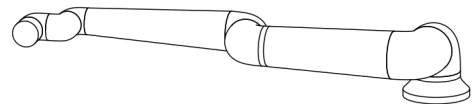
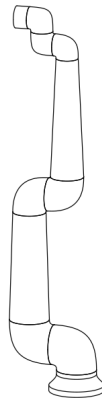

Secure the tubes to a solid surface. Secure attached end effector in 3 axes.

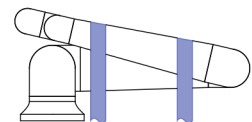
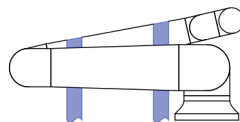

## 15.2. Teach Pendant Storage

**Description** The operator needs to have a clear understanding about what the e-Stop on the Teach Pendant affects when pressed. For example there can be confusion with a multi-robot installation. It should be made clear if the e-Stop on the Teach Pendant stops the whole installation or only its connected robot.  
If there could be confusion, store the Teach Pendant such that the e-Stop button is not visible or usable.

---

## 15.3. Long Term Storage

---

**Description** This section describes general guidelines for long-term storage of robots and spare parts. This applies for all robot generations and spare parts.

A robot is considered long-term stored when it is stored for a period of 6 months or more.

---

**Guidelines** In order to keep the robot and spare parts in its best possible condition, it is recommended to follow normal good practice which is:

- Storage temperature: 10°C - 30°C
- Humidity: RH 20-60%
- Universal Robots recommends to unpack and start up robots at least **yearly** and let them run a light load program rotating in all joints at least 90 degrees 5 times in each direction to distribute the lubricants.  
If possible, also mount spare parts joints on an arm and perform the same operation routine.
- In rare occurrences there may be a need for wiping down the robots after storage to remove any excess lubricants that have migrated out of the sealings.
- The battery is designed to last for the lifetime of the robot and will not be charged when power is applied to the system. The battery service life is 8 to 10 years, but for e-Series and UR Series it can be replaced.
- Flash memory can lose their data capacity over time, therefore there is a potential risk that the data on e.g. the SD-card will have to re-flashed.

---

# 16. Maintenance and Repair

---

**Description** Any maintenance work, inspection and calibration shall be conducted in compliance with all safety instructions in this manual, the UR Service Manual, and according to local requirements.  
Repair work shall be done by Universal Robots. Client designated, trained individuals can do repair work, provided they follow the Service Manual.

---

**Safety for Maintenance** The purpose of maintenance and repair is to ensure the system is kept functioning as expected.  
When working on the robot arm or control box, you must observe the procedures and warnings below.



## WARNING

Failure to adhere to any of the safety practices, listed below, can result in injury.

- Unplug the main power cable from the bottom of the Control Box to ensure that it is completely unpowered. Power off any other source of energy connected to the robot arm or Control Box. Take necessary precautions to prevent other persons from powering on the system during the repair period.
- Check the earth connection before re-powering the system.
- Observe ESD regulations when parts of the robot arm or Control Box are disassembled.
- Prevent water and dust from entering the robot arm or Control Box.

**Safety for Maintenance**



**WARNING**

Failure to leave space to accommodate the Control Box with the door fully open can lead to injury.

- Provide at least 915 mm of space to enable the Control Box door to open fully, providing access for servicing.



**WARNING: ELECTRICITY**

Disassembling the Control Box power supply too quickly after switching off, can result in injury due to electrical hazards.

- Avoid disassembling the power supply inside the Control Box, as high voltages (up to 600 V) can be present inside these power supplies for several hours after the Control Box has been switched off.

After troubleshooting, maintenance, and repair work, ensure that safety requirements are fulfilled. Adhere to national or regional work safety regulations. The correct functioning of all safety function settings shall also be tested and validated.

**Lockout Tagout**

UR robots can be de-energized and locked in the de-energized state. This is to control hazardous energy due to tasks associated with installation, maintenance or repair of the robot, robot application or robot cell.

To perform "Lockout" or "control of hazardous energy" of the power to the robot, you can use a power plug lock to prevent the power cord from being reattached to the Control Box, for example Brady 148081 Plug Lockout for IEC.



**WARNING: ELECTRICITY**

Exposure to hazardous energy or the release of contained hazardous energy can result in electrical shock and serious injury.

- Use a power plug lockout to prevent the power cord from being reattached to the control box. For example see Brady 148081 Plug Lockout for IEC plug or equivalent.

## 16.1. Testing Stopping Performance

**Description**

Test periodically to determine if stopping performance is degraded. Increased stopping times can require safeguarding to be modified, possibly with changes to the installation. If stop time and/or stop distance safety functions are used and are the basis of the risk reduction strategy, no monitoring or testing of stopping performance is required. The robot does continuous monitoring.

## 16.2. Robot Arm Cleaning and Inspection

---

**Description** As part of regular maintenance the robot arm can be cleaned, in accordance with the recommendations in this manual and local requirements.

---

**Cleaning Methods** To address the dust, dirt, or oil on the robot arm and/or Teach Pendant, simply use a cloth alongside one of the cleaning agents provided below.

**Surface Preparation:** Before applying the below solutions, surfaces may need to be prepared by removing any loose dirt or debris.

**Cleaning agents:**

- Water
- 70% Isopropyl alcohol
- 10% Ethanol alcohol
- 10% Naphtha (Use to remove grease.)

**Application:** The solution is typically applied to the surface that needs cleaning using a spray bottle, brush, sponge, or cloth. It can be applied directly or diluted further depending on the level of contamination and the type of surface being cleaned.

**Agitation:** For stubborn stains or heavily soiled areas, the solution may be agitated using a brush, scrubber, or other mechanical means to help loosen the contaminants.

**Dwell Time:** If necessary, the solution is allowed to dwell on the surface for a up to 5 minutes to penetrate and dissolve the contaminants effectively.

**Rinsing:** After the dwell time, the surface is typically rinsed thoroughly with water to remove the dissolved contaminants and any remaining cleaning agent residue. It's essential to ensure thorough rinsing to prevent any residue from causing damage or posing a safety hazard.

**Drying:** Finally, the cleaned surface may be left to air dry or dried using towels.



**WARNING**

DO NOT USE BLEACH in any diluted cleaning solution.

**WARNING**

Grease is an irritant and can cause an allergic reaction. Contact, inhalation or ingestion can cause illness or injury. To prevent illness or injury, adhere to the following:

- **PREPARATION:**
  - Ensure that the area is well ventilated.
  - Have no food or beverages around the robot and cleaning agents.
  - Ensure that an eye wash station is nearby.
  - Gather the required PPE (gloves, eye protection)
- **WEAR :**
  - Protective gloves: Oil resistant gloves (Nitrile) impermeable and resistant to product.
  - Eye protection is recommended to prevent accidental contact of grease with eyes.
- **DO NOT INGEST.**
- In the event of
  - contact with skin, wash with water and a mild cleaning agent
  - a skin reaction, get medical attention
  - contact with the eyes, use an eyewash station, get medical attention.
  - inhalation of vapors or ingestion of grease, get medical attention
- After grease work
  - clean contaminated work surfaces.
  - dispose responsibly of any used rags or paper used for cleaning.
- Contact with children and animals is prohibited.

**Robot Arm Inspection Plan**

The table below is a checklist of the type of inspections recommended by Universal Robots. Perform inspections regularly as advised in the table. Any referenced parts found to be in an unacceptable state must be rectified or replaced.

Inspection action type			Timeframe		
			Monthly	Biannually	Annually
1	Check flat rings	V		X	
2	Check robot cable	V		X	
3	Check robot cable connection	V		X	
4	Check Robot Arm mounting bolts *	F	X		
5	Check Tool mounting bolts *	F	X		
6	Round Sling	F			X

**Robot Arm Inspection Plan**



**NOTICE**

Using compressed air to clean the robot arm can damage the robot arm components.

- Never use compressed air to clean the robot arm.

**Robot Arm Inspection Plan**

1. Move the Robot Arm to ZERO position, if possible.
2. Turn off and disconnect the power cable from Control Box.
3. Inspect the cable between Control Box and Robot Arm for any damage.
4. Check the base mounting bolts are properly tightened.
5. Check the tool flange bolts are properly tightened.
6. Inspect the flat rings for wear and damage.
  - Replace the flat rings if they are worn out or damaged.



**NOTICE**

If any damage is observed on a robot within the warranty period, contact the distributor where the robot was purchased.

**Inspection**

1. Unmount any tool/s or attachment/s or set the TCP/Payload/CoG according to tool specifications.
2. To move the robot arm in Freedrive:
  - On a 3PE Teach Pendant, rapidly light-press, release, light-press again and keep holding the 3PE button in this position.

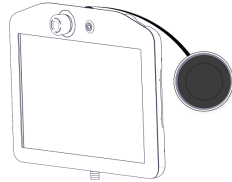

Power button

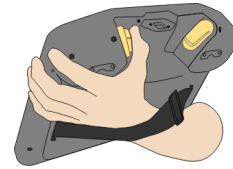

3PE button

3. Pull/Push the robot to a horizontally elongated position and release.

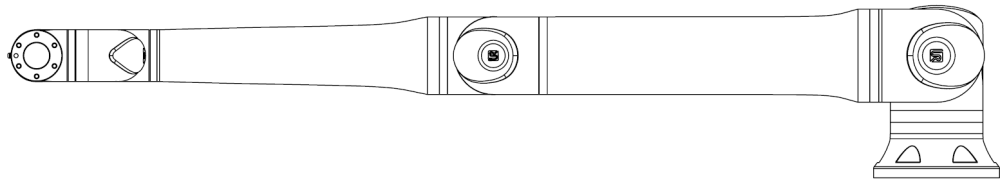

4. Verify the robot arm can maintain the position without support and without activating Freedrive.

## 16.3. Cleaning TP and CB

### Cleaning the Teach Pendant Touch Screen

Use a mild, industrial cleaning agent without thinning agents or any aggressive additives. Do not use an abrasive material to wipe down the screen. Universal Robots does not promote a specific cleaning agent.

### Cleaning the Control Box

Wipe down the Control box with a damp cloth, if necessary. Use the cleaning recommendation listed in the user manual.

**Replace the  
Control box  
Filters**

There is a filter on either side of the control box.

1. Gently remove the outer plastic frame by pulling where the red arrows are, as shown in the images below in figure 3.7. The frame tilts outward.
2. Replace filters.

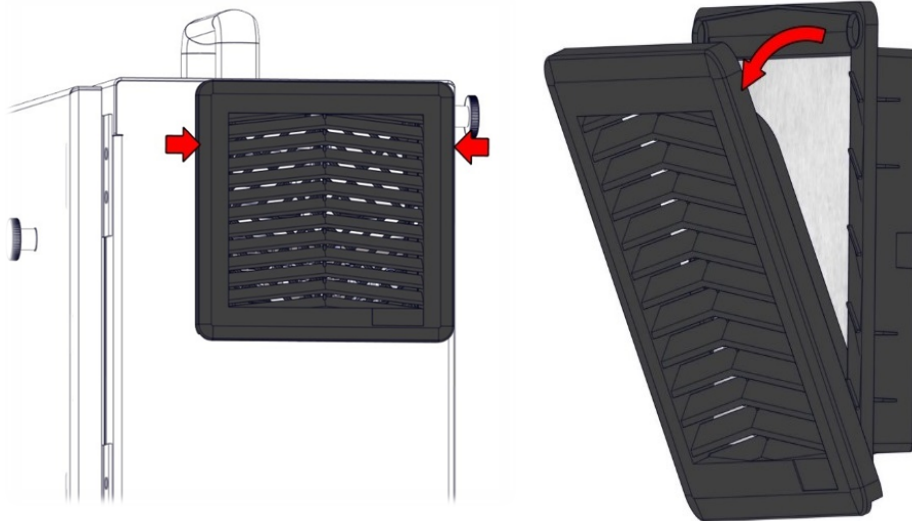
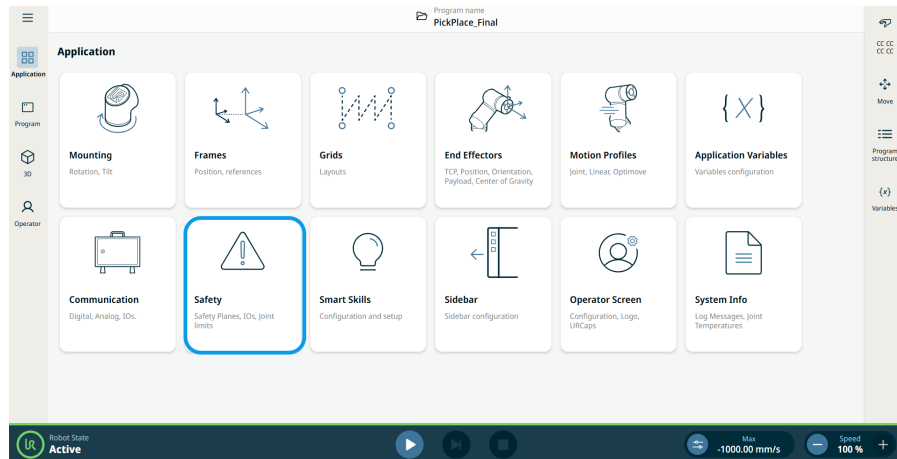

Figure 3.7. Replace the Control box filters.

## 16.4. Software Installation

To configure the 3PE TP software

1. On PolyScope, in the left menu, tap **Application** and select **Safety**.



2. Tap **Hardware** and the **Unlock** button.

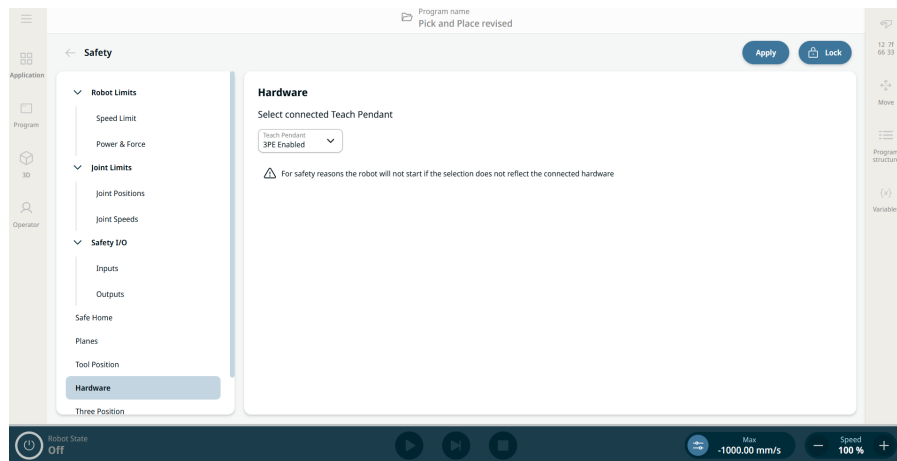

3. Enter the password and tap **Confirm**. Teach Pendant is now enable.
4. Tap **Apply** to restart the system. PolyScope continues to run.
5. Tap **Apply and restart** then **Confirm Configuration** to complete the 3PE Teach Pendant software installation.

# 17. Disposal and Environment

---

**Description** Universal Robots robots must be disposed of in accordance with the applicable national laws, regulations and standards. this responsibility rests with the owner of the robot.

UR robots are produced in compliance with restricted use of hazardous substances to protect the environment; as defined by the European RoHS directive 2011/65/EU. If robots (robot arm, Control Box, Teach Pendant) are returned to Universal Robots Denmark, then the disposal is arranged by Universal Robots A/S.

The disposal fee for UR robots sold on the Danish market is prepaid to DPA-system by Universal Robots A/S. Importers in countries covered by the European WEEE Directive 2012/19/EU must make their own registration to the national WEEE register of their country. The fee is typically less than 1€/robot.

You can find a list of national registers here: <https://www.ewrn.org/national-registers>.  
Search for Global Compliance here: <https://www.universal-robots.com/download>.

---

**Substances in the UR robot****Robot arm**

- Tubes, Base Flange, Tool mounting bracket: Anodized aluminum
- Joint housings: Powder coated aluminum
- Black band sealing rings: AEM rubber
  - additional slip ring under black band: moulded black plastic
- Endcaps/ lids: PC/ASA Plastic
- Minor mechanical components e.g. screws, nuts, spacers (steel, brass, and plastic)
- Wire bundles with copper wires and minor mechanical components e.g. screws, nuts, spacers (steel, brass, and plastic)

**Robot arm joints (internal)**

- Gears: Steel and grease (detailed in the Service Manual)
- Motors: Iron core with copper wires
- Wire bundles with copper wires, PCB's, various electronic components and minor mechanical components
- Joint seals and O-rings contain a small amount of PFAS which is a compound within PTFE (commonly known as Teflon™).
- Grease: synthetic + mineral oil with a thickener of either lithium complex soap or Urea. Contains molybdenum.
  - Depending on model and date of production, the color of the grease could be yellow, magenta, dark pink, red, green.
  - The Service Manual details the handling precautions and Grease Safety Data Sheets

**Control box**

- Cabinet (enclosure): Powder coated steel
    - Standard Control Box
  - Aluminum sheet metal housing (internal to the cabinet). This is also the housing of the OEM controller.
    - Standard Control Box and OEM controller.
  - Wire bundles with copper wires, PCB's, various electronic components, plastic connectors, and minor mechanical components e.g. screws, nuts, spacers (steel, brass, and plastic)
  - A lithium battery is mounted to a PCB. See the Service Manual for how to remove.
-

# 18. Declarations and Certifications

## 18.1. Declaration of Incorporation (original)



**EU Declaration of Incorporation (DOI)** (in accordance with 2006/42/EC Annex II B)

original: EN

<b>Manufacturer:</b>		<b>Person in the Community Authorized to Compile the Technical File:</b>	
Universal Robots A/S Energivej 51, DK-5260 Odense S DK		David Brandt, Technology Officer, Compliance Universal Robots A/S, Energivej 25, DK-5260 Odense S Denmark	
<b>Description and Identification of the Partly-Completed Machine(s):</b>			
<b>Product and Function:</b>	Industrial robot multi-purpose multi-axis manipulator with standard control box, standard length cables & with or without UR 3PE teach pendant. Function is determined by the completed machine (robot application or cell with end-effector, intended use and application program).		
<b>Model:</b>	UR8Long, UR15, UR18, UR20, UR30 with a standard control box: <i>NOTE: This DOI is NOT applicable when the OEM Controller is used. See control box markings.</i>		
<b>Serial Number:</b>	Starting <b>2024 6 8 00252</b> and higher for the UR20* <small>year —   — Sequential numbering, restarting at 0 each year</small> <small>series —   — <b>6 = UR8Long, 7 = UR15, 5 = UR18, 8 = UR20, 9 = UR30</b></small>		
*TÜV Rheinland certifications: <b>UR20:</b> 11 Mar '24 (#00252). <b>UR30:</b> 14 Mar '24. <b>UR15:</b> May '25. <b>UR8Long</b> (#00019) & <b>UR18</b> (#00012): 31 Jul '25			
<b>Incorporation:</b>	Universal Robots UR8Long, UR15, UR18, UR20 & UR30 shall only be put into service upon being integrated into a final complete machine (robot application or robot cell), which conforms with the provisions of the Machinery Directive and other applicable Directives.		
It is declared that the above products fulfil, for what is supplied, the following directives as detailed below: When this partly completed machine is integrated and becomes a complete machine, the integrator is responsible for the completed machine fulfilling all applicable Directives, applying the CE mark and providing the Declaration of Conformity (DOC).			
<b>I. Machinery Directive 2006/42/EC</b>	<b>The following essential requirements have been fulfilled:</b> 1.1.2, 1.1.3, 1.1.5, 1.1.6, 1.2.1, 1.2.4.3, 1.2.5, 1.2.6, 1.3.1, 1.3.2, 1.3.4, 1.3.8.1, 1.3.9, 1.4.1 with 3PE TP, 1.5.1, 1.5.2, 1.5.4, 1.5.5, 1.5.6, 1.5.8, 1.5.10, 1.6.3, 1.7.1.1, 1.7.2, 1.7.4, 1.7.4.1, 1.7.4.2, 4.1.2.1, 4.1.2.3, 4.1.2.5 (sling), 4.1.3, 4.3.3, Annex VI. It is declared that the relevant technical documentation has been compiled in accordance with Part B of Annex VII of the Machinery Directive.		
<b>II. Low-voltage Directive 2014/35/EU</b>	Reference the LVD and the harmonized standards used below.		
<b>III. EMC Directive 2014/30/EU</b>	Reference the EMC Directive and the harmonized standards used below.		
<b>Reference to the harmonized standards used, as referred to in Article 7(2) of the MD &amp; LV Directives and Article 6 of the EMC Directive:</b>			
(I) EN ISO 10218-1:2011 ✖ (I) EN ISO 12100:2010 (I) EN ISO 13849-1:2015 ✖ 2023 edition has no relevant changes (I) EN ISO 13849-2:2012 ✖ See TÜV Rheinland Certificates	(I) EN ISO 13732-1:2008 (I) EN ISO 13850:2015 (I) EN IEC 60204-1:2018 as applicable (I, II) EN 60947-5-5:1997+A1:2005 +A11:2013+A2:2017	(I) EN IEC 60947-5-8:2014 & 2021 (III) EN IEC 61000-3-2:2014 & 2019 (III) EN 61000-3-3:2013 (III) EN 61000-6-2: 2012 & 2019 (II) EN 61140:2002/A1:2006 & 2016	
<b>Reference to other technical standards and technical specifications used:</b>			
(I) ISO 9409-1:2004 (I) ISO/TS 15066:2016 as applicable (III) EN 60068-2-1:2007 (III) EN 60068-2-2:2007	(III) EN 60068-2-27:2009 (III) EN 60068-2-64:2008+A1:2019 (II) EN IEC 60320-1:2021 (II) EN 60529:1991/AC:2016	(II) EN 60664-1:2007 (III) EN IEC 61000-6-4:2023 (II) EN IEC 61784-3:2021 [SIL2] (III) EN 61326-3-1:2017 [Industrial locations SIL 2]	
The manufacturer, or his authorised representative, shall transmit relevant information about the partly completed machinery in response to a reasoned request by the national authorities.			
Approval of full quality assurance system by the notified body Bureau Veritas: ISO 9001 certificate #DK019348, ISO 14001 certificate DK019349, and ISO 45001 certificate #DK019350.			

Odense Denmark, 25 August 2025



**Roberta Nelson Shea**, Global Technical Compliance Officer

*This DOI can change without notice. DOIs are in User Manuals. Most recent User Manuals & DOIs are available from the UR website.*







## 18.2. Certifications UR18

### Description

Third party certification is voluntary. However, to provide the best service to robot integrators, Universal Robots chooses to certify its robots at the recognized test institutes listed below.

You can find copies of all certificates in the chapter: Certificates.

### Certification

 <p>EN ISO 10218-1 EN ISO 13849-1 www.tuv.com ID 0007000000</p>	<p>TÜV Rheinland</p>	<p>Certificates by TÜV Rheinland to EN ISO 10218-1 and EN ISO 13849-1. TÜV Rheinland stands for safety and quality in virtually all areas of business and life. Founded 150 years ago, the company is one of the world's leading testing service providers.</p>
	<p>TÜV Rheinland</p>	<p>The cTUVus mark shows that a product complies with US and Canadian safety standards, proving conformity with US and Canadian electrical safety standards.</p>
	<p>Fraunhofer IPA</p>	<p>Universal Robots UR Series robots conform to Fraunhofer Institute for Manufacturing Engineering and Automation testing.</p>
	<p>CHINA RoHS</p>	<p>Universal Robots products conform to CHINA RoHS requirements for controlling pollution by electronic information products. A product declaration table is provided.</p>
	<p>KCs</p>	<p>Universal Robots products have been assessed and conform to KOSHA safety standards.</p>
	<p>KC</p>	<p>Universal Robots products have been evaluated for conformity Korea's EMC requirements.</p>
	<p>Delta</p>	<p>Universal Robots products are performance tested by DELTA.</p>

### Supplier Third Party Certification

	<p>Environment</p>	<p>As provided by our suppliers, Universal Robots e-Series robots shipping pallets comply with the ISMPM-15 Danish requirements for producing wood packaging material and are marked in accordance with this scheme.</p>
---	--------------------	--

**Manufacturer Test Certification**

	Universal Robots	Universal Robots e-Series robots undergo continuous internal testing and end of line test procedures. UR testing processes undergo continuous review and improvement.
---	------------------	---

**Declarations according to EU directives**

Although EU directives are relevant for Europe, some countries outside Europe recognize and/or require EU declarations. European directives are available on the official homepage: <http://eur-lex.europa.eu>. According to the Machinery Directive, Universal Robots' robots are partly completed machines, as such a CE mark is not to be affixed. You can find the Declaration of Incorporation (DOI) according to the Machinery Directive in the chapter: Declarations and Certificates.

### 18.3. Certificates UR18



**TÜV Rheinland  
North America  
UL1740**

# Certificate

**Certificate no.** CU 72503109 0001

**License Holder:**  
Universal Robots A/S  
Energivej 51  
5260 Odense S  
Denmark

**Manufacturing Plant:**  
See additional page(s) for the listing of 3  
factories

**Report Number:** US25JQ7X 002      **Client Reference:** Roberta Nelson Shea  
**Certification acc. to:** UL 1740:2018 R8.23  
CAN/CSA-Z434-14 + GI1 (R2019)

**Product Information**

**Certified Product:** Industrial Robot  
**Model Designation:** UR15, UR20, UR30, UR8 Long, UR18  
**Technical Data:** Rated Voltage: a) AC 100-200V, 50/60Hz;  
b) AC 200-240V, 50/60Hz  
Rated Current: a) 15A; b) 8A  
Protection Class: I

Special Remarks: The following safety functions have been evaluated and determined to meet Pld Cat. 3 per EN ISO 13849-1:2015:

1- Emergency Stop	2- Safeguard Stop
3- Joint Position Limit	4- Joint Speed Limit
5- Pose Limit	6- Cartesian Speed Limit
7- Force Limit	8- Momentum Limit
9- Power Limit	10- Stopping Time Limit
11- Stopping Distance Limit	12- System Emergency Stop Output
13- Robot Moving Digital Output	
14- Robot Not Stopping Digital Output	
15- Reduced Mode Digital Output	
16- Not Reduced Mode Digital Output	
17- 3 Position Enabling Device INPUT	

Refer to product manual for additional information.  
Must be installed and programmed in accordance with the manufacturer's instructions. Certificate is only valid within used in conjunction with the UR Control Box, with or without a UR TeachPendant.

© TÜV, TÜV and TÜV are registered trademarks. Utilization and application requires prior approval.

**Remarks:** Replaces Certificate CU72501652.  
**Appendix:** 1, 1-59

TUV Rheinland of North America, Inc.  
400 Beaver Brook Rd, Boxborough, MA 01719  
Tel +1 (978) 266 9500, Fax +1 (978) 266-9992

www.tuv.com



Copyright © 2009-2026 by Universal Robots A/S. All rights reserved.

KC  
Registration

2435-7743-4B60-FE96

<b>방송통신기자재등의 적합등록증</b> <i>Registration of Broadcasting and Communication Equipments</i>	
상호 또는 성명 Trade Name or Registrant	Universal Robots A/S
기자재명칭(제품명칭) Equipment Name	Industrial Robot
기기부호/추가 기기부호 Equipment code /Additional Equipment code	IND
기본모델명 Basic Model Number	UR18
파생모델명 Series Model Number	
등록번호 Registration No.	R-R-URK-UR18
제조사/제조국가 Manufacturer/Country of Origin	Universal Robots A/S/덴마크
등록연월일 Date of Registration	2025-10-15
기타 Others	
<p>위 기자재는 「전파법」 제58조의2 제3항에 따라 등록되었음을 증명합니다.                      It is verified that foregoing equipment has been registered under the Clause 3, Article 58-2 of Radio Waves Act.</p> <p style="text-align: right;">2025년(Year) 10월(Month) 15일(Day)</p> <p style="text-align: center;">국립전파연구원장                        Director General of National Radio Research Agency</p> <p style="text-align: center; color: red;">※ 적합등록 방송통신기자재는 반드시 "<b>적합성평가표시</b>" 를 부착하여 유통하여야 합니다.                      위반시 과태료 처분 및 등록이 취소될 수 있습니다.</p>	

Copyright © 2009-2026 by Universal Robots A/S. All rights reserved.

KC Safety



자율안전확인 신고증명서

신청인	사업장명	Universal Robots A/S	사업장관리번호	2016E110079
	사업자등록번호	016E110079	대표자 성명	Jean-Pierre Hathout
	소재지	Energivej51, 5260 Odense SDenmark		
자율안전인증대상 기계·기구명		산업용로봇		
형식(규격)	UR18	용량(등급)	6 axis	
자율안전확인번호	25-AB2EQ-02414			
제조사	Universal Robots A/S			
소재지	Energivej51, 5260 Odense SDenmark			

「산업안전보건법」 제89조제1항 및 같은 법 시행규칙 제120조제3항에 따라 자율안전확인 신고증명서를 발급합니다.

2025년 11월 25일

한국산업안전보건공단 이사장



# 19. Safety Functions Table

## Description

Universal Robots safety functions and safety I/O are PLd Category 3 (ISO 13849-1), where each safety function has a PFH value less than 1.8E-07.

The PFH values are updated to include greater design flexibility for supply chain resilience.

For safety I/O the resulting safety function including the external device, or equipment, is determined by the overall architecture and the sum of all PFHs, including the UR robot safety function PFH.

If any safety function limit is exceeded or a fault is detected in a safety function or safety-related part of the control system, UR defines the safe state as a stop with removal of drive power (either a stop category 1 or 0<sup>4</sup> immediate removal of power).

### SF1

1, 2, 3, 4

### Emergency Stop (ISO 13850)

Description	What happens?	Tolerance	Affects
Pressing the Estop PB on the pendant <sup>1</sup> or the External Estop (if using the Estop Safety Input) results in a Stop Cat 1 <sup>4</sup> with power removed from the robot actuators and the tool I/O. Controller I/O go "low". Command <sup>1</sup> all joints to stop and upon all joints coming to a monitored standstill state, power is removed. See Stop Time & Stop Distance Safety Functions <sup>5</sup> . <b>ONLY USE FOR EMERGENCY PURPOSES</b> , not to be used for safeguarding, because actuation requires a manual action.	Stop Category 1 (IEC 60204-1)	--	Robot, robot tool I/O, and controller I/O

### SF2

3, 5

### Safeguard Stop

(Protective Stop according to ISO 10218-1\*)

\*Prior to 2006, this was called "safety stop" or "safeguard stop"

Description	What happens?	Tolerance	Affects
This safety function is initiated by an external protective device using safety inputs which will initiate a Stop Cat 2 <sup>4</sup> . The purpose is to protect people from injury, as compared to protecting the robot, equipment, or products. The tool I/O are unaffected by the safeguard stop. If an enabling device is connected, it is possible to configure the safeguard stop to function in automatic mode ONLY. See the Stop Time and Stop Distance Safety Functions. <sup>5</sup>	Stop Category 2 (IEC 60204-1) SS2 stop (as described in IEC 61800-5-2)	--	Robot

### Safeguard Stop Reset

Description	What happens?	Tolerance	Affects
When configured for Safeguard Reset and the external reset connections transition from low to high, safeguard stop resets. Safety input to initiate a reset of SF2.	Reset Input to SF2	--	Robot

**SF3  
Joint Position  
Limit  
(software-  
based axis  
limiting)**

Description	What happens?	Tolerance	Affects
<p>Sets upper and lower limits for the allowed joint positions. Stopping time and distance is not considered as the limit(s) will not be violated. Each joint can have its own limits.</p> <p><i>Directly limits the set of allowed joint positions that the joints can move within. It is safety-rated soft axis limiting &amp; space limiting, according to ISO 10218-1:2011, 5.12.3.</i></p>	<p><b>Will not allow motion to exceed any limit settings.</b></p> <p>Speed could be reduced so motion will not exceed any limit.</p> <p>A robot stop will be initiated to prevent exceeding any limit.</p>	5°	Joint (each)

**SF4  
Joint  
Speed  
Limit**

Description	What happens?	Tolerance	Affects
<p>Sets an upper limit for the joint speed. Each joint can have its own limit. This safety function has the most influence on energy transfer upon contact (clamping or transient).</p> <p><i>Directly limits the set of allowed joint speeds which the joints are allowed to perform. It is used to limit fast joint movements, e.g. risks related to singularities.</i></p>	<p><b>Will not allow motion to exceed any limit settings.</b></p> <p>Speed could be reduced so motion will not exceed any limit.</p> <p>A robot stop will be initiated to prevent exceeding any limit.</p>	1.15 °/s	Joint (each)

**Joint Torque Limit** Exceeding the internal joint torque limit (each joint) results in a Cat 0 Stop<sup>4</sup>. This safety function is not accessible to the user; it is a factory setting. It is NOT shown as here because there are no user settings.

**SF5  
Called various  
names:  
Pose Limit  
Tool Limit,  
Orientation  
Limit, Safety  
Planes,  
Safety  
Boundaries**

Description	What happens?	Tolerance	Affects
<p>Monitors the TCP Pose (position and orientation) and will prevent exceeding a safety plane or TCP Pose Limit.</p> <p>Multiple pose limits are possible (tool flange, elbow, and up to 2 configurable tool offset points with a radius)</p> <p>Orientation restricted by the deviation from the feature Z direction of the tool flange OR the TCP.</p> <p><i>Two parts. (1) is the safety planes for limiting the possible TCP positions. (2) is the TCP orientation limit, which is entered as an allowed direction and a tolerance. This provides TCP and wrist inclusion/exclusion zones due to the safety planes.</i></p>	<p>Will not allow motion to exceed any limit settings. Speed or torques could be reduced so motion will not exceed any limit set for SF 5, SF 6, SF 7 or SF 8.</p>	3° 40 mm	TCP Tool flange Elbow

**SF6  
Speed  
Limit TCP  
& Elbow**

Description	What happens?	Tolerance	Affects
Monitors the <b>TCP</b> and <b>elbow</b> speed to prevent exceeding a speed limit. Equivalent to monitoring the whole arm as the sections between the TCP and elbow cannot move faster than the endpoints of these sections.	A robot stop will be initiated to prevent exceeding any limit.  <b>Will not allow motion to exceed any limit settings.</b>	50 mm/s	TCP

**SF7  
Force  
Limit  
(TCP)**

Description	What happens?	Tolerance	Affects
The Force Limit is the force exerted by the robot at the TCP (tool center point) and " <b>elbow</b> ". The safety function continuously calculates the torques allowed for each joint to stay within the defined force limit for both the TCP & the elbow. The joints control their torque output to stay within the allowed torque range. This means that the forces at the TCP or elbow will stay within the defined force limit. When a stop is initiated by the Force Limit SF, the robot will stop. The UR standard controller will cause motion to "back-off" to the position before the force limit was exceeded. This "back-off" is not part of the safety function as it is done by the standard controller. The safety controller has a fixed time (part of the response time) allowed before a robot stop is initiated.	A robot stop will be initiated to prevent exceeding any limit.  <b>Will not allow motion to exceed any limit settings.</b>	25 N	TCP

**SF8  
Momentum  
Limit**

Description	What happens?	Tolerance	Affects
The momentum limit is very useful for limiting transient impacts. <i>The Momentum Limit affects the entire robot.</i>	A robot stop will be initiated to prevent exceeding any limit.  <b>Will not allow motion to exceed any limit settings.</b>	3 kg m/s	Robot

**SF9  
Power  
Limit**

Description	What happens?	Tolerance	Affects
This function monitors the mechanical work (sum of joint torques times joint angular speeds) performed by the robot, which also affects the current to the robot arm as well as the robot speed. This safety function dynamically limits the current/torque but maintains the speed.	Dynamic limiting of the current/torque	10 W	Robot

**SF10  
UR Robot  
Stop  
Outputs**

Description	What Happens	Tolerance	Affects
<p>When configured for a robot stop output and there is a robot stop, the dual outputs are LOW. If there is no robot stop initiated, dual outputs are high. Pulses are not used but they are tolerated. For an integrated safety function, see footnote.<sup>6</sup></p> <p>These dual outputs change state for any external Estop that is connected to configurable safety inputs where this input is configured as an Emergency Stop input.</p> <p>For the Stop Output, validation is performed at the external equipment, as the UR output is an input to this external stop safety function for external equipment.</p>	<p>Dual outputs go low in event of a stop if configurable outputs are set</p>	<p>N/A</p>	<p>External connection to logic and/or equipment</p>
<div style="border: 1px solid black; padding: 5px;">  <p><b>NOTICE</b></p> <p>This stop output is not connected to the IMMI (Injection Moulding Machine Interface), to prevent having an unrecoverable stop.</p> </div>			

**SF11  
"Moving"  
Safety  
Function  
with Digital  
Outputs**

Description	What Happens	Tolerance	Affects
<p>Whenever the robot is moving (motion underway), the dual digital outputs are LOW. Outputs are HIGH when no movement.</p> <p>Functional safety is for what is within the UR robot. For an integrated safety function, see footnote.<sup>6</sup></p>	<p>Dual outputs are low during motion and high when no movement.</p>	<p>N/A</p>	<p>External connection to logic and/or equipment</p>

**SF12  
"Not  
stopping"  
Safety  
Function  
with Digital  
Outputs**

Description	What happens?	Tolerance	Affects
<p>Whenever the robot is STOPPING (in process of stopping or in a stand-still condition) the dual digital outputs are HIGH. When outputs are LOW, robot is NOT in the process or stopping and NOT in a stand-still condition. For an integrated safety function, see footnote.<sup>6</sup></p>	<p>Dual outputs are high when robot is either in the process of stopping or at a stand-still state</p>	<p>N/A</p>	<p>External connection to logic and/or equipment</p>

**SF13  
"Reduced  
Active"  
Safety  
Function  
with Digital  
Outputs**

Description	What happens?	Tolerance	Affects
<p>When reduced settings are active (or initiated) for safety functions, the dual digital outputs are LOW. The functional safety is for what is within the UR robot. For the integrated safety function, see footnote.<sup>6</sup></p>	<p>Dual outputs are low when reduced settings are active</p>	<p>N/A</p>	<p>External connection to logic and/or equipment</p>

**SF14  
"Reduced  
Not Active"  
Safety  
Function  
with Digital  
Outputs**

Description	What happens?	Tolerance	Affects?
<p>Whenever the robot reduced settings for safety functions are NOT active (or not initiated), the digital outputs are LOW.</p> <p>The functional safety rating is for what is within the UR robot.</p> <p>For the integrated safety function, see below footnote.<sup>6</sup></p>	<p>Dual outputs are low when reduced settings are NOT active.</p>	<p>N/A</p>	<p>External connection to logic and/or equipment.</p>

**“Reduced Active” Input SF parameter settings change**

Description	Affects
<p>Reduced is not a mode. It is a change of settings initiated:</p> <ul style="list-style-type: none"> <li>internally by a safety plane/ boundary (starts when at 2cm of the plane and reduced settings are achieved within 2cm of the plane) or</li> <li>externally by use of an external input, which will achieve reduced settings within 500ms of the triggering input.</li> </ul> <p>When the external connections are Low, Reduced Mode is initiated. "Reduced Active" makes all reduced limits ACTIVE.</p> <p>Reduced is not a safety function. Reduced is a means of parameterization of safety functions.</p> <p>Reduced is a state change affecting the settings of the following safety functions: joint position, joint speed, TCP pose, TCP speed, TCP force, momentum, power, stopping time, &amp; stopping distance.</p> <p>Verify and validate all parameter settings for the robot application.</p>	<b>Robot</b>

**SF15 Stopping Time Limit**

Description	What happens?	Tolerances	Affects
<p>Real time monitoring of conditions such that the stopping time limit will not be exceeded. Robot speed is limited to ensure that the stop time limit is not exceeded. <sup>7</sup></p>	<p><b>Will not allow the actual stopping to exceed the limit setting.</b></p> <p>Causes decrease in speed or a robot stop so as NOT to exceed the limit.</p>	50 ms	Robot

**SF16 Stopping Distance Limit**

Description	What happens?	Tolerances	Affects
<p>Real time monitoring of conditions such that the stopping distance limit will not be exceeded. Robot speed is limited to ensure that the stop distance limit will not be exceeded. <sup>7</sup></p>	<p><b>Will not allow the actual stopping to exceed the limit setting.</b></p> <p>Causes decrease in speed or a robot stop so as NOT to exceed the limit.</p>	40 mm	Robot

**SF17 Safe Home Position "monitored position"**

Description	What happens?	Tolerances	Affects
<p>Safety function which monitors a safety-rated output, such that it ensures that the output can only be activated when the robot is in the configured and monitored "safe home position".</p> <p>A stop cat 0 is initiated if the output is activated when the robot is not in the configured position.</p>	<p>The "safe home output" is only activated when the robot is in the configured "safe home position"</p>	1.7 °	<b>External connection to logic and/or equipment</b>

**Mode switch INPUT**

Description	What happens?	Affects
<p>When the external connections are Low, Automatic Mode (running) is active. When High, mode is programming/ teach.</p> <p><b>Recommendation:</b> Use with an enabling device, i.e. UR Teach Pendant with an integrated 3-position enabling device.</p> <p>When in teach/program, initially the TCP speed is limited to 250mm/s. Speed can manually be increased using the TP "speed-slider", but upon activation of the enabling device, the speed limitation will reset to 250mm/s.</p>	Input to SF2	Robot

**SF18 (3-position enabling) Safety Function<sup>8</sup> Inputs**

Description	What happens?	Tolerance	Affects
<p><b>A 3-position enabling device<sup>9</sup> has 3 switch positions: off, on, off</b> (in order of actuation when squeezing). When released completely, the device is off. When pressed/squeezed to the centre position, it is on. Completely pressing (squeezing) results in an off state. When the 3P enabling device is "ON", motion is enabled.</p> <p><b>When in Manual Mode</b> and when an external Enabling Device connection is OFF, internally the safety system initiates SF2, which is a Stop Category 2.</p> <p><b>Recommendation:</b> Use with a mode switch as a safety input.<sup>10</sup></p>	<p><b>In manual mode, when the SF18 Input is LOW, SF2 is triggered internally</b></p> <p>Stop Category 2 (IEC 60204-1) SS2 (IEC 61800-5-2)</p>	N/A	<b>Robot and external connection to SF19 &amp; SF20</b>

**SF19 3PE (3-position enabling) Safety Function<sup>8</sup> with Digital Outputs**

Description	What happens?	Tolerance	Affects
<p><b>In Automatic Mode ("running"), SF19's outputs are HIGH.</b></p> <p><b>In Manual Mode</b> and when any Enabling Device<sup>11</sup> is in the OFF state (not in the centre-ON position, meaning the enabling device is released or fully pressed), a SF2 is triggered causing a Stop Category 2 (SS2) and SF19's outputs are Low.<sup>8</sup></p> <p><b>In Manual mode, when Freedrive and the 3PE are used:</b></p> <ul style="list-style-type: none"> <li>• <b>If Freedrive is activated and</b> <ul style="list-style-type: none"> <li>• <u>ALL</u> 3PE are in the OFF state, SF19's outputs are HIGH.</li> <li>• <u>Any</u> 3PE is in the ON state, SF19's outputs are LOW.</li> </ul> </li> <li>• <b>If Freedrive is not activated, and</b> <ul style="list-style-type: none"> <li>• <u>ALL</u> 3PE are in the ON state, SF19's outputs are HIGH.</li> <li>• <u>Any</u> 3PE is in the OFF state, SF19's outputs are LOW.</li> </ul> </li> </ul>	<p><b>In manual mode, when the 3PE is in the Off state, the outputs are LOW and SF2 is triggered internally</b></p> <p>Stop Category 2 (IEC 60204-1) SS2 (IEC 61800-5-2)</p>	N/A	<b>External connection to logic and/or equipment</b>

**SF20  
3PE (3-  
position  
enabling)  
"NOT state"  
Safety  
Function<sup>8</sup>  
with Digital  
Outputs**

Description	What happens?	Tolerance	Affects
<p><b>In Automatic Mode ("running"), SF20's outputs are LOW.</b></p> <p><b>In Manual Mode</b> and when any Enabling Device<sup>11</sup> is in the OFF state (not in the centre-ON position, meaning the enabling device is released or fully pressed), SF20's outputs are High.<sup>7</sup></p> <p>In Manual mode, when Freedrive and the 3PE are used:</p> <ul style="list-style-type: none"> <li>• <b>If Freedrive is activated and:</b> <ul style="list-style-type: none"> <li>• <u>ALL</u> 3PE are in the OFF state, SF20's outputs are LOW.</li> <li>• <u>Any</u> 3PE is in the ON state, then SF20's outputs are HIGH.</li> </ul> </li> <li>• <b>If Freedrive is not activated, and:</b> <ul style="list-style-type: none"> <li>• <u>ALL</u> 3PE are in the ON state, SF20's outputs are LOW.</li> <li>• <u>Any</u> 3PE is in the OFF state, SF20's outputs are HIGH.</li> </ul> </li> </ul> <p><b>Note:</b> SF20 is an inverted version of the SF19 where the output state is logically reversed compared to SF19.</p>	<p><b>In manual mode, when the 3PE is in the Off state, the outputs are HIGH.</b></p>	N/A	<p><b>External connection to logic and/or equipment</b></p>

**SF21  
Wrist  
clamping  
torque limit**

Description	What happens?	Tolerance	Affects
<p>Monitors the torque of the wrist joints to avoid high clamping torques. Will not allow the wrist clamping torque limit to exceed the limit.</p> <div style="border: 1px solid black; padding: 5px; margin-top: 10px;"> <p><b>NOTICE</b> This safety function can be configured to be disabled.</p> </div>	<p><b>Causes a robot stop so as NOT to exceed the limit</b></p>	N/A	<p><b>Robot</b></p>

**SF22  
Outputs  
activated by  
a Safety  
Plane (SF5)**

Description	What happens?	Tolerance	Affects
<p>Whenever the monitored TCP pose has crossed the safety plane, the dual outputs are LOW.</p> <p>Multiple poses can trigger the dual outputs (tool flange, elbow, and up to 2 configurable tool offset points with a radius)</p> <p>See Tool Position Restriction for further details.</p>	<p><b>The outputs are LOW when the monitored TCP pose crosses the safety plane.</b></p>	<p><b>40mm</b> same as SF5</p>	<p><b>External connection to logic and/or equipment</b></p>

**SF23  
Safety  
Plane (SF5)  
activated by  
inputs**

Description	What happens?	Tolerance	Affects
<p>When both INPUTS are:</p> <ul style="list-style-type: none"> <li>• HIGH.                             <ul style="list-style-type: none"> <li>• The monitored TCP pose can move freely.</li> </ul> </li> <li>• LOW.                             <ul style="list-style-type: none"> <li>• The Safety Function's intended result is to prevent the monitored TCP pose from crossing the safety plane. However, this is not possible if there is insufficient time or distance to stop.</li> <li>• If the monitored TCP pose has already crossed the safety plane or the monitored TCP pose is about to cross the safety plane, then the Robot will stop according to stopping time and stopping distance limit settings.</li> </ul> </li> </ul> <p>See Tool Position Restriction for further details.</p>	<p>When</p> <ul style="list-style-type: none"> <li>• both inputs are LOW, and</li> <li>• the monitored TCP pose is moving towards the safety plane, and</li> <li>• there is sufficient time or distance to stop before reaching the safety plane, a robot stop is initiated to prevent exceeding the safety plane.</li> </ul> <p>If there is insufficient time or distance to stop before reaching the safety plane, a robot stop is initiated which will comply with the configured stopping time and stopping distance limit settings. However, the monitored TCP pose will pass the safety plane.</p>	<p><b>40mm</b> same as SF5</p>	<p><b>TCP Tool flange Elbow</b></p>

**Table 1**  
**footnotes**

- <sup>1</sup>**Communications** between the Teach Pendant, controller & within the robot are SIL 2 for safety data (per IEC 61784-3).
- <sup>2</sup>**Estop validation:** The pendant Estop pushbutton is evaluated within the pendant, then communicated<sup>1</sup> to the safety controller by SIL2 communications. To validate the pendant Estop functionality, press the Pendant Estop pushbutton and verify that an Estop results. This validates that the Estop is connected within the pendant, the estop functions as intended, and the pendant is connected to the controller.
- <sup>3</sup>**If a robot safety function** is “integrated” or “connected” with external equipment, devices or logic, the resulting integrated safety function has a PFH that is the sum of all PFH values, including the PFH value of the robot safety function.
- <sup>4</sup>**Stop Categories** according to IEC 60204-1 (NFPA79). For the Estop, only stop category 0 and 1 are allowed.
- **Stop Category 0 & 1** result in the removal of drive power, with stop cat 0 being IMMEDIATE & stop cat 1 being a controlled stop (e.g. decelerate to a stop then removal of drive power).
  - **Stop Category 2** is a stop where drive power is NOT removed. Stop category 2 is defined in IEC 60204-1. Descriptions of STO, SS1 & SS2 are in IEC 61800-5-2. With UR, a stop category 2 maintains the trajectory & retains power to the drives after stopping.
- <sup>5</sup> **Stop Time & Stop Distance** Safety Functions should be used. When used, there is no need for periodic verification of stopping performance.
- <sup>6</sup> **If a robot safety function** is “integrated” or “connected” with external equipment, devices or logic, the resulting integrated safety function has a PFH that is the sum of all PFH values, including the PFH value of the robot safety function.
- <sup>7</sup> The stopping capability of the robot in the given motion(s) is continuously monitored to prevent motions that would exceed the stopping limit. If the time needed to stop the robot is at risk of exceeding the time limit, the speed of motion is reduced to ensure the limit is not exceeded. A stop will be initiated to prevent exceeding the limit.
- <sup>8</sup> For the integrated functional safety rating with an external safety-related control system, add the PFH of this safety-related output to the PFH of the external safety-related control system. The safety function and its triggering of a stop are included in the PFH value for this SF.
- <sup>9</sup> The enabling device can be on the teach pendant or external connected to the Enabling Function input (SF18).
- <sup>10</sup> Use of an external mode switch is recommended when using a 3-position enabling device. If an external mode switch is not used and connected to the safety inputs, then the robot mode will be determined by the User Interface. If the User Interface is in
- “automatic mode”, the enabling function will not be active.
  - “manual mode”, the enabling function will be active. Password protection for changing the mode can be configured.
- <sup>11</sup> If any 3PE enabling device is released or fully pressed, the 3-position enabling safety function is OFF (not in the Center ON position).
-



Software Name: PolyScope X  
Software Version: 10.13  
Document Version: 10.18.364

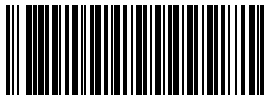

762-344-00



762-344-00